



TJEP 9/20 HP



Technical specifications

Model	TJEP 9/20 HP
TJEP no.	123074
Length	450 mm
Width	317 mm
Height	363 mm
Weight	13.8 kg
HP	2
Power supply	Single-phase 230 – 240 VAC 50 Hz \pm 1 % Φ = 1
Current	6.3 A
Maximum pressure	42 bar
Working temperature	0-40°C
IP class	IP20



OBS

Læs altid manualen.

ATTENTION

Always read the manual.

BITTE BEACHTEN

*Bitte lesen Sie die
Bedienungsanleitung*

Service

DK: +45 97 14 14 40

DE: +49 711 34238732

SE: +46 036 2937502

NO: +47 23 96 08 54

EU: +45 97 14 14 40

Declaration of conformity



Manufacturer: Hitachi Industrial Equipment Systems Co., Ltd.
AKS Bldg., 3, Kanda Neribeicho, Chiyoda-ku,
Tokyo 101-0022, Japan

Herewith declares conformity of the product:

Type: TJEP 9/20 HP

With applicable regulations below

EC Directive: Machinery Directive: 2006/42/EC
EMC Directive: 2014/30/EU
Noise Directive: 2000/14/EC

Harmonized European Standards applied:

EN 60335-1 : 2012 +A1, +A2, +A11, +A12, +A13, +A14
(see TUV Rheinland test report No. 50054363 001)
EN 61000-6-4 : 2007 +A1 : 2011
EN 61000-6-2 : 2005
(see TUV Rheinland test report No. 50059430 001)
EN ISO 3744 : 1995
(see EC conformity certificate No. SNCH*2000/14*2005/88*2993*00)

Authorized representative in EU / TCF holder:

Kyocera Unimerco Fastening A/S
Drejervej 2, DK-7451 Sunds, Denmark

Division: Hitachi Industrial Equipment Systems Co., Ltd.

Japan 7th January, 2017

Place and Date

General Manager

Susumu Sakamoto

Name/Signature/Position

Note: This Declaration certifies conformity with the above mentioned Directives, but gives no assurance of properties within the meaning of the Law concerning product liability. It becomes invalid if any technical or other modifications are carried out without manufacturers consent.

TJEP 9/20 HP

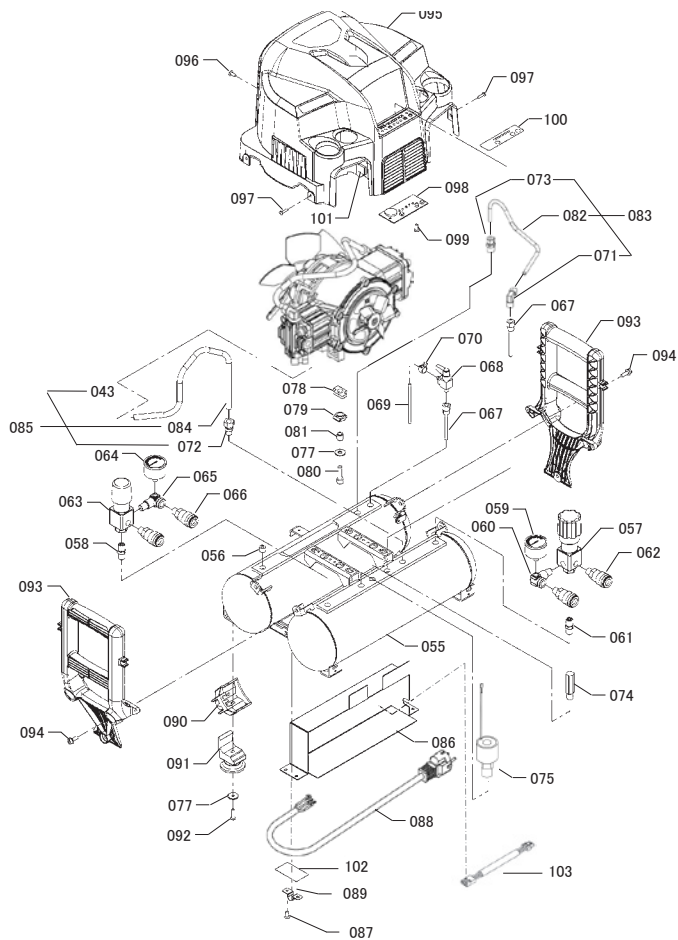

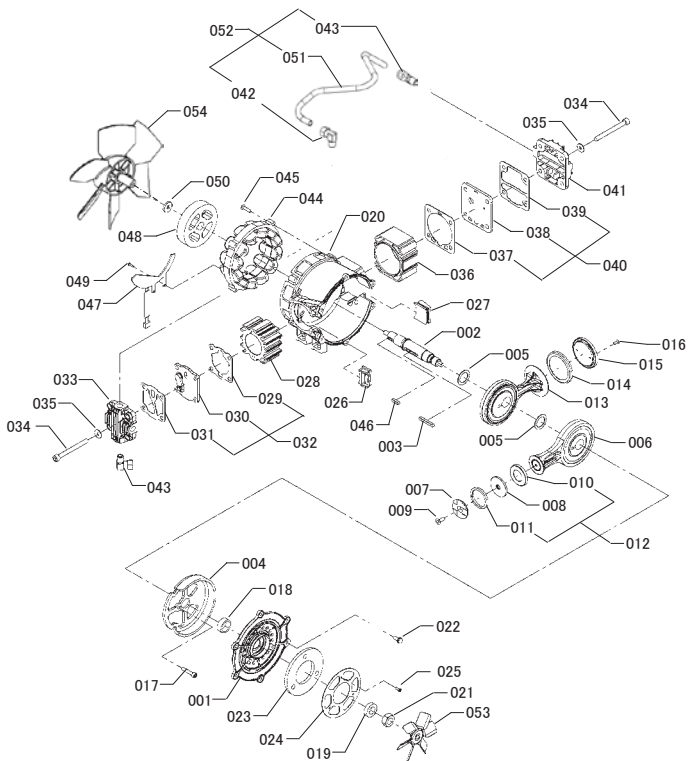

Spare parts

Item No.	Code No.	Part Name
1	744097	Bearing Box Assy
2	744130	Shaft Assy
3	744099	Key (Eccentric)
4	744101	Balance (Flywheel)
5	744103	Spacer (Eccentric)
6	744106	Connecting Rod (H) Assy
7	744107	Top
8	744108	Base
9	744109	Screw (M6)
10	744110	Lip Ring (H)
11	744112	Piston Ring
12	744113	Ring Set (H)
13	744114	Connecting Rod (L) Assy
14	741108	Lip Ring (L)
15	755530	Retainer (L)
16	740771	Screw (M5)
17	755532	Bolt
18	742627	Collar (Bearing)
19	743246	Collar (Nut)
20	744115	Crank Case Assy
21	744116	Nut
22	760540	Screw (with Spring Washer)
23	744117	Filter
24	744118	Filter Cover
25	760541	Tapping Screw
26	744119	Bush (H)

Item No.	Code No.	Part Name
27	744120	Bush (L)
28	741682	Cylinder (H)(D45)
29	744121	Packing (Air Valve) (H)
30	760542	Air Valve Assy (H)
31	741684	Packing (Head) (H)
32	744122	Air Valve Set (H)
33	741686	Cylinder Head (H)
34	742340	Bolt
35	743408	Washer (D8) 10
36	741681	Cylinder (L)
37	742807	Packing (Air Valve) L
38	760543	Air Valve Assy (L)
39	741274	Packing (Head) L
40	743244	Air Valve Set (L)
41	755333	Cylinder Head (L)
42	755859	Joint Assy
43	740737	Joint Assy
44	744123	Stator
45	744124	Button Head Bolt
46	744125	Key (Rotor)
47	744126	Rotating sensor
48	744127	Rotor
49	744128	Screw
50	742936	Rotor Washer
51	779488	Pipe (Intermediate)
52	744139	Pipe (Intermediate) Set
53	744134	Fan
54	759524	Fan

Item No.	Code No.	Part Name
55	760529	Air Tank Assy
56	760533	Plug
57	760523	Reducing Valve (25K)
58	744143	Nipple
59	760545	Pressure Gauge
60	744144	Joint (Coupler H)
61	740381	Nipple
62	744145	Female Coupler (H)
63	760524	Reducing Valve Assy
64	760526	Pressure Gauge
65	744147	Joint (Coupler L)
66	760521	Female Coupler (L)
67	755546	Joint (Drain Valve)
68	742304	Drain Valve
69	755364	Vinyl Tube
70	755383	Hose Band
71	755052	Joint Assy (Elbow Union)
72	752333	Joint Assy (Half Union)
73	752141	Joint Assy (Half Union)
74	742801	Relief Valve
75	760570	Pressure Sensor
77	744151	Washer
78	741053	Mount Rubber (Compressor)
79	741052	Mount Rubber (Air Tank)
80	760534	Bolt
81	741438	Collar

Item No.	Code No.	Part Name
82	779909	Pipe (Communicating)
83	779910	Pipe (Communicating) Set
84	744154	Pipe (Discharge)
85	744155	Pipe (Discharge) Set
86	760531	Control System Assy
87	760535	Tapping Screw
88	760520	Code
89	760536	Saddle
90	755374	Installation Rubber Holder
91	744159	Installation Rubber
92	760537	Tapping Screw
93	760527	Handle
94	744164	Bolt (with Flange)
95	760522	Cover Assy
96	760538	Tapping Screw
97	760539	Tapping Screw
98	760518	Switch Terminal Board
99	743432	Tapping Screw 10
100	760528	Switch Sheet
101	744168	Rubber Plate
102	760544	Rubber Plate
103	760517	Motor Code



KYOCERA UNIMERCO Fastening A/S
Drejervej 2
DK-7451 Sunds
Tlf. +45 97 14 14 40
Fax +45 97 14 14 86
tjep@kyocera-unimerco.com