

Carl Ras varenr. 41843156 – Terno Magic/1800 skydedørsbeslag – skjult skinne!

VIGTIGT!

Reklamationer grundet skæve gulve, samt unøjagtig montering af vægrulle accepteres ikke.

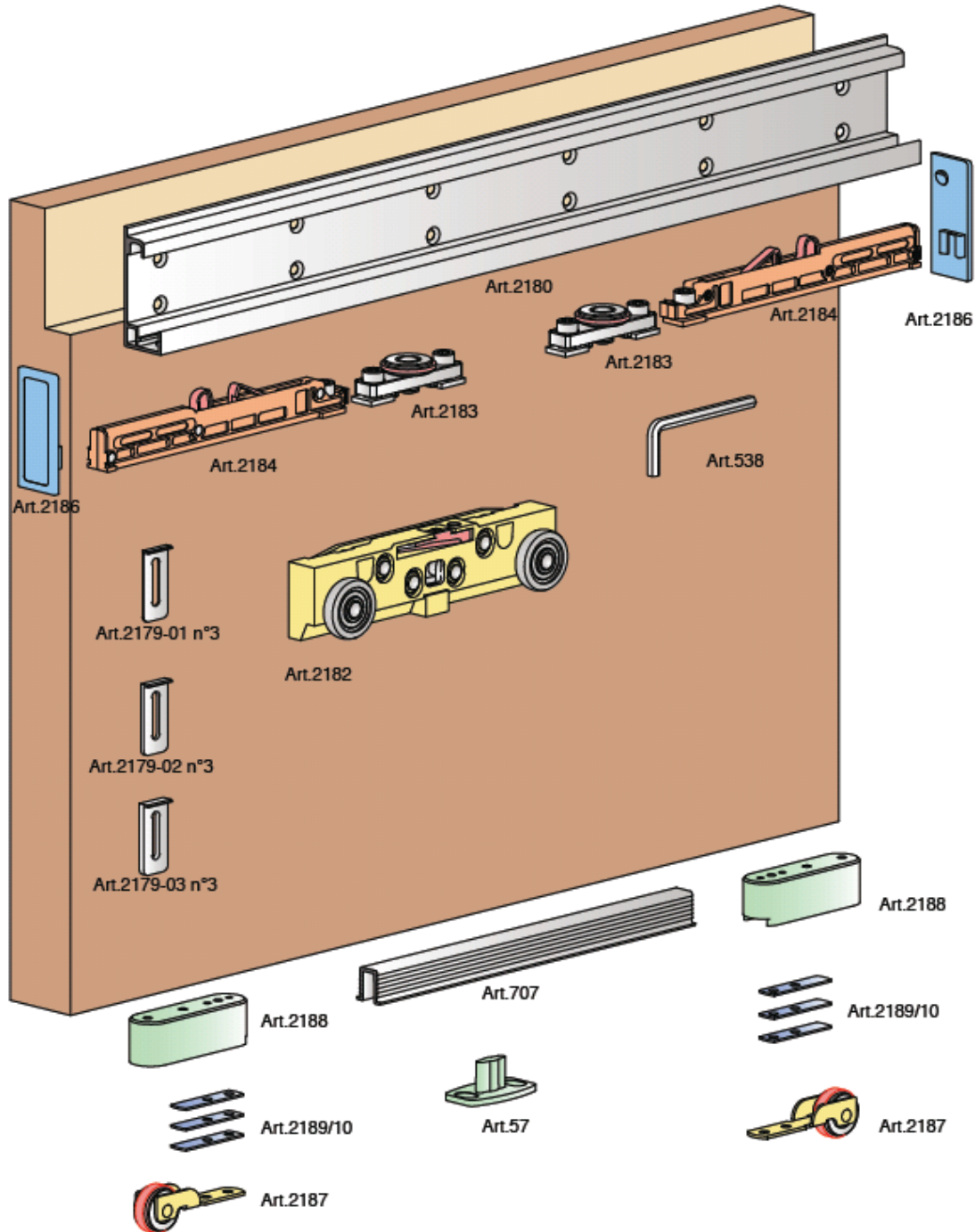

Udfresning af dørplade:

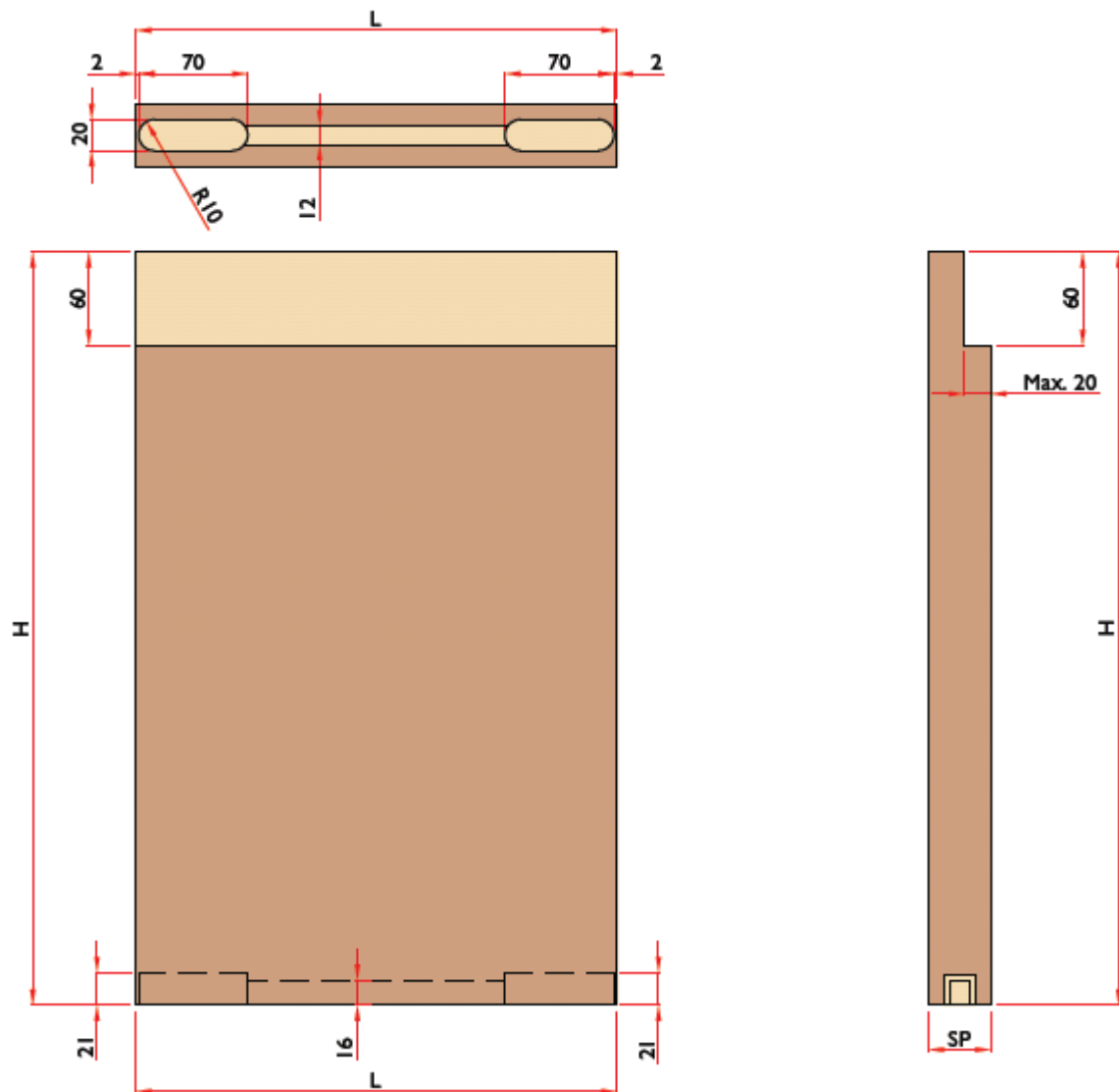

Afkortning af skinner:

MISURE DI TAGLIO DEI PROFILI
PROFILES CUTTING MEASUREMENTS

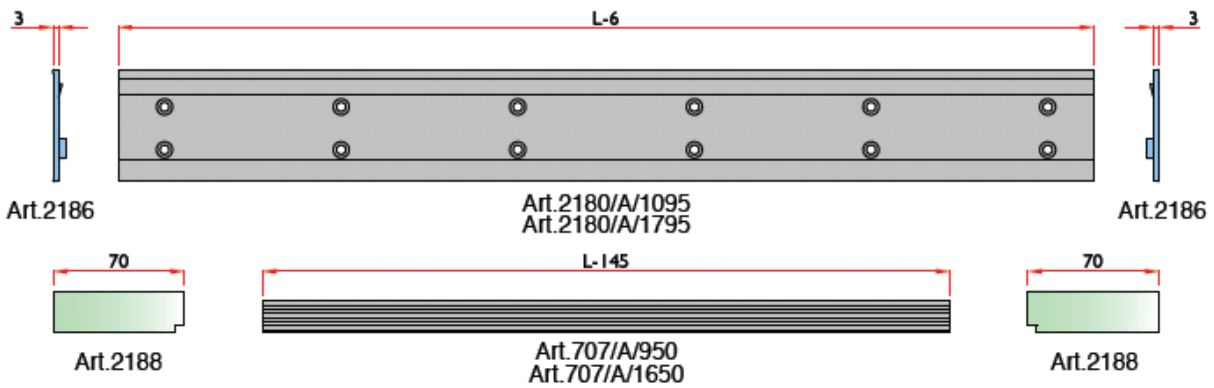
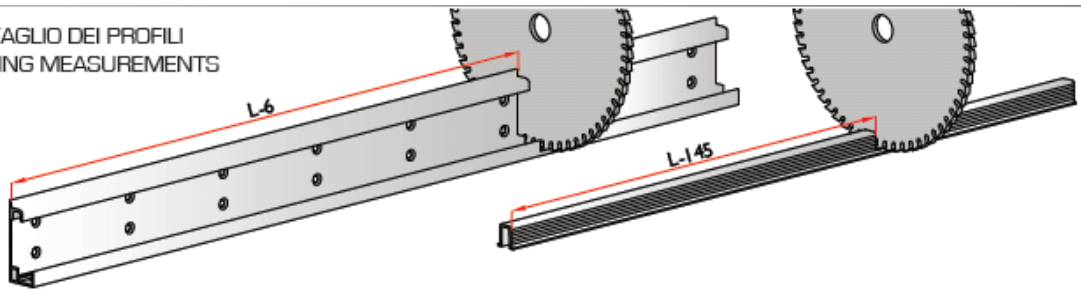

carl ras engros beslag

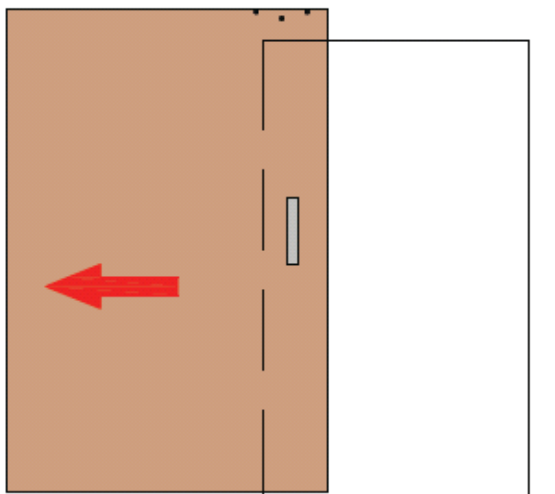
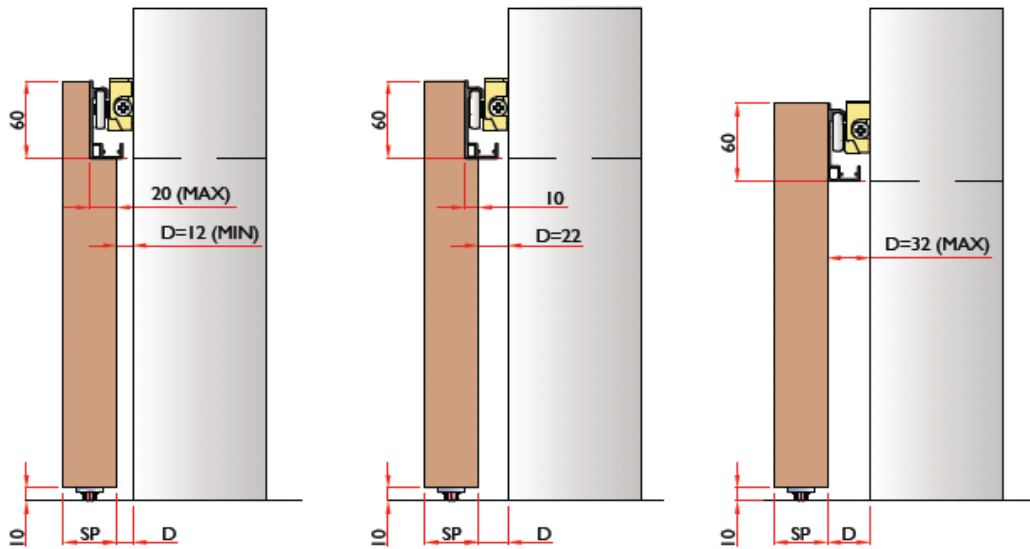
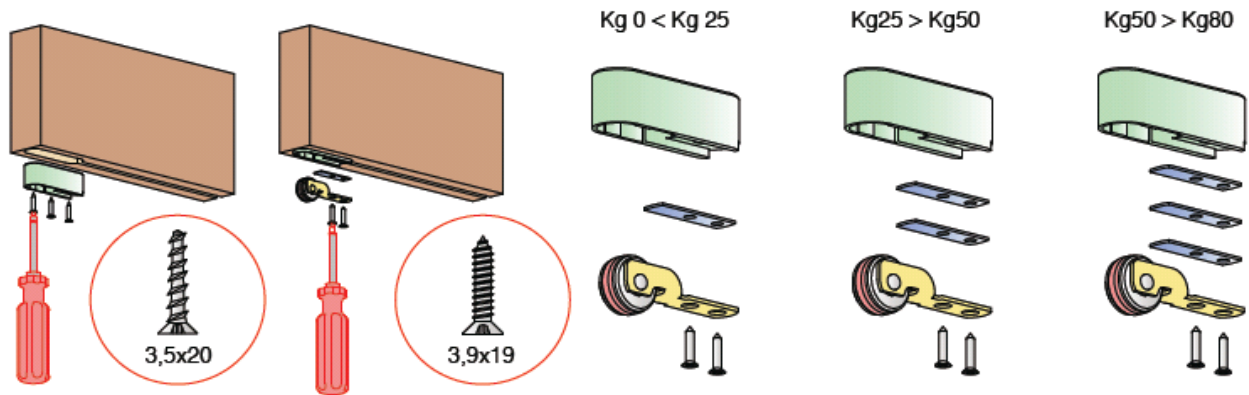

Venstre åbnende

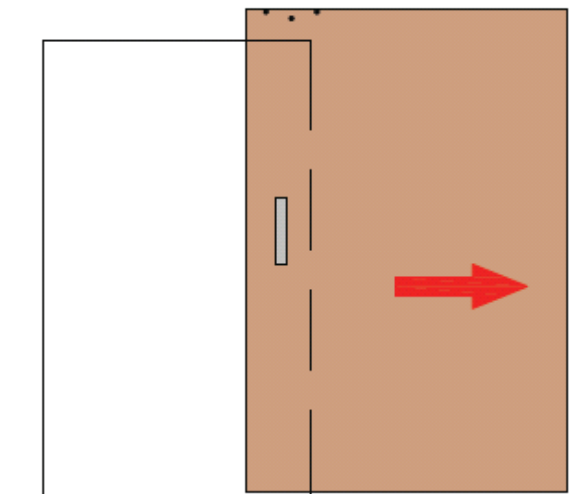

Højre åbnende

STANDARD POSITION

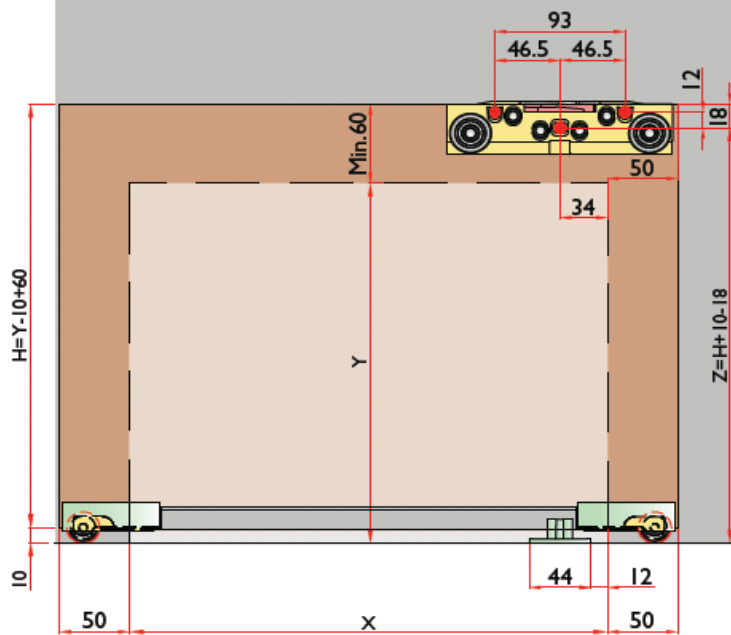
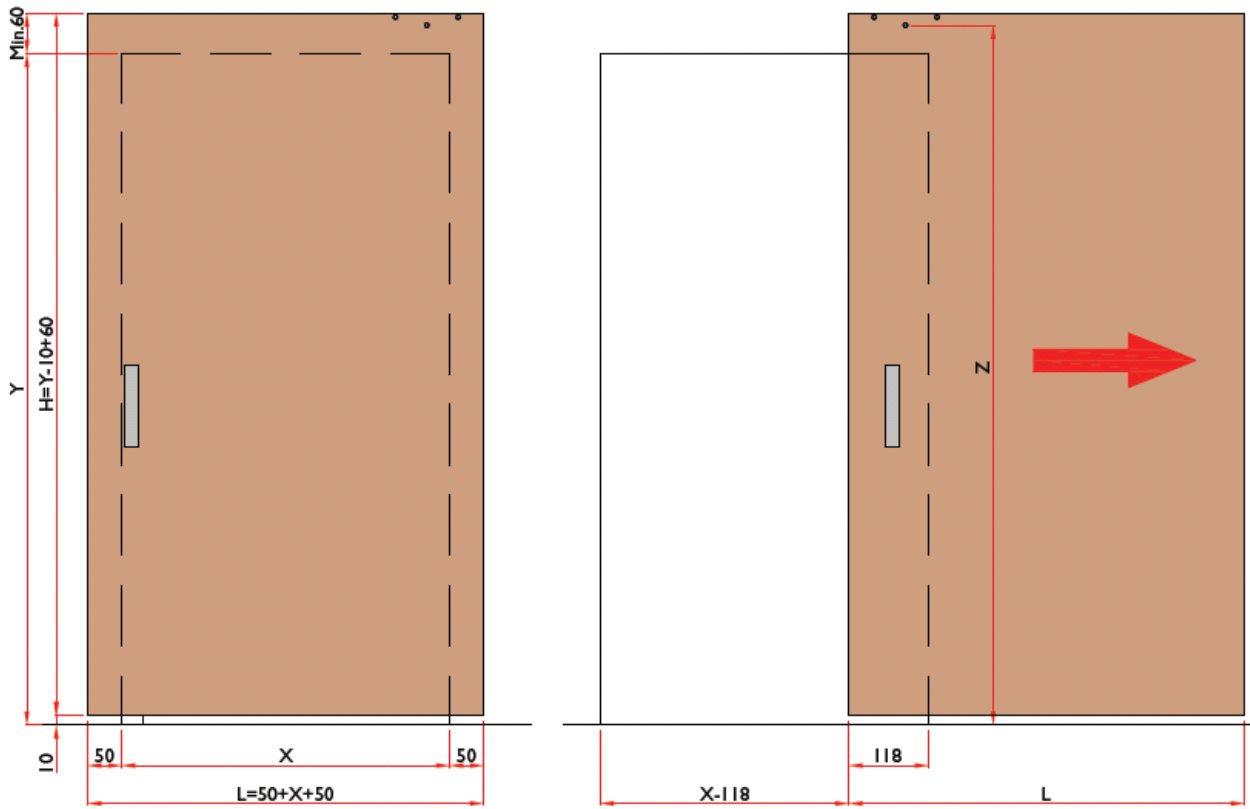

ART.MAGIC/1100
 X= MIN.800 (L=900)
 X= MAX.1000 (L=1100)

ART.MAGIC/1800
 X= MIN.800 (L=900)
 X=MAX.1700 (L=1800)

INTERMEDIATE POSITION

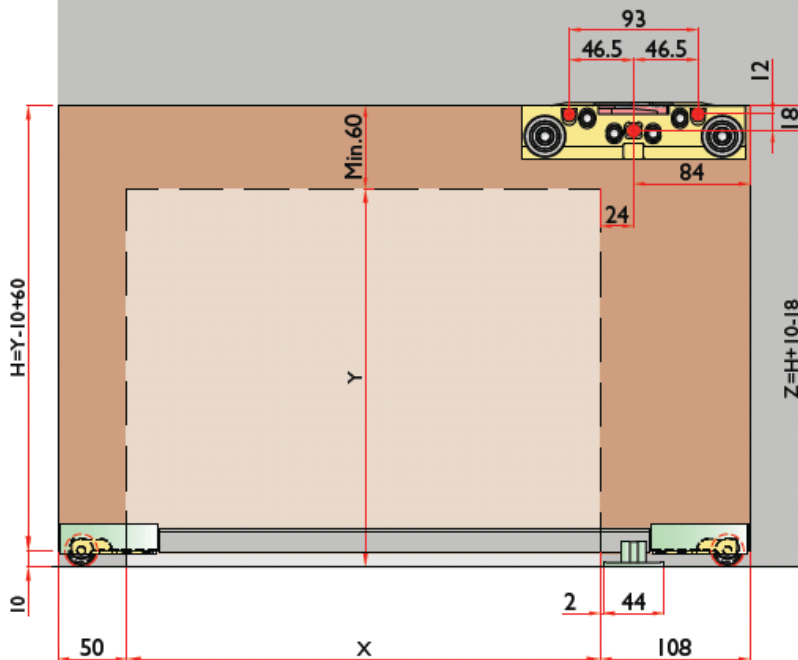
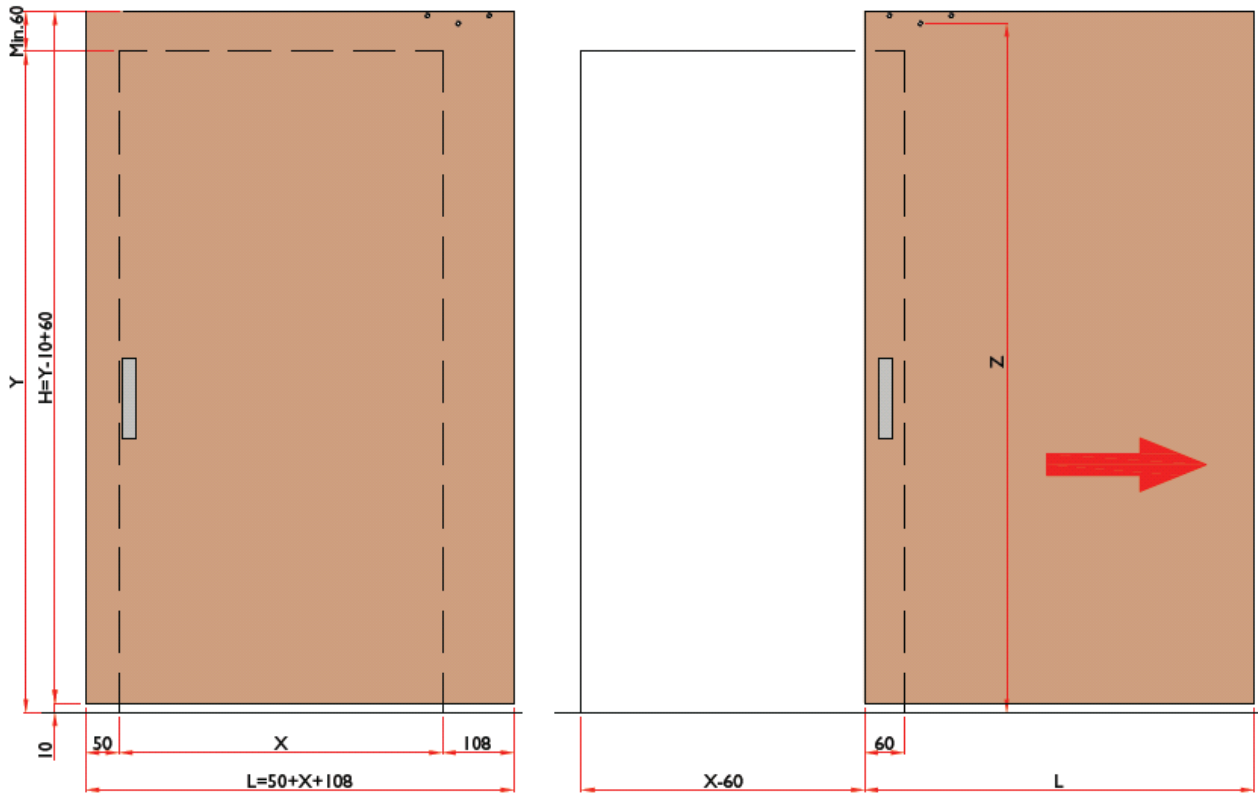

ART.MAGIC/ 1100
 X= MIN.740 (L=900)
 X= MAX.940 (L=1100)

ART.MAGIC/ 1800
 X= MIN.740 (L=900)
 X=MAX.1640 (L=1800)

TOTAL OPENING POSITION

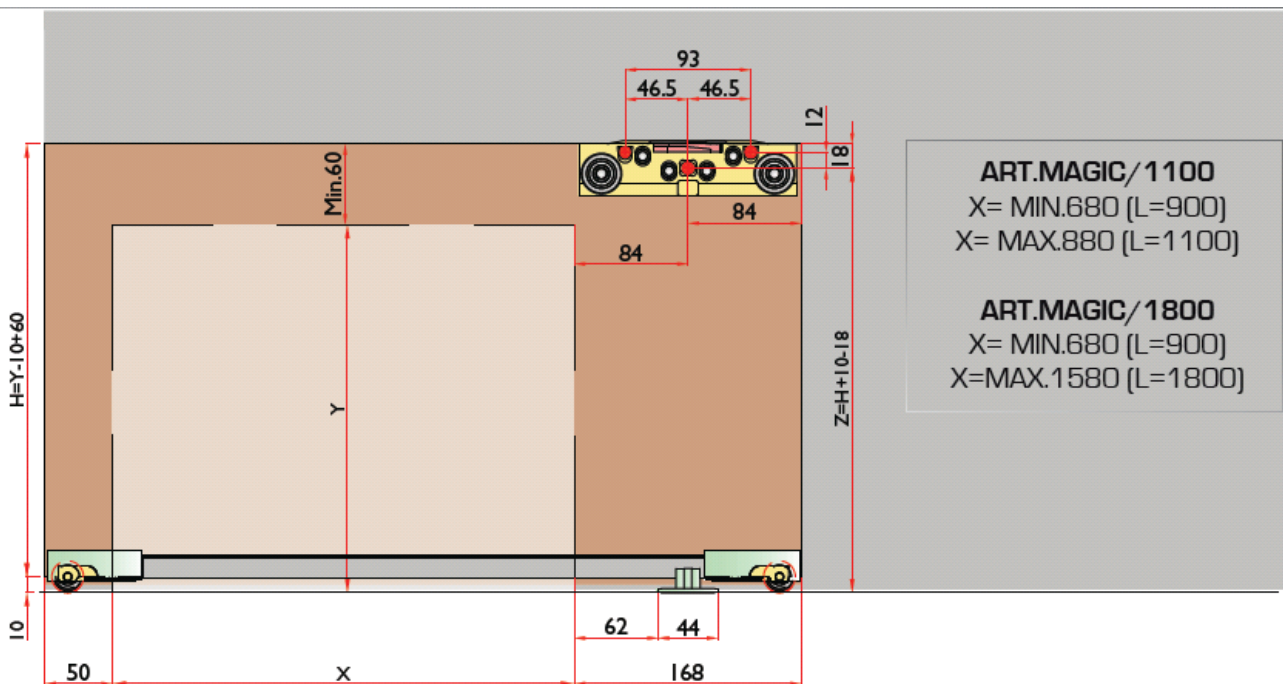
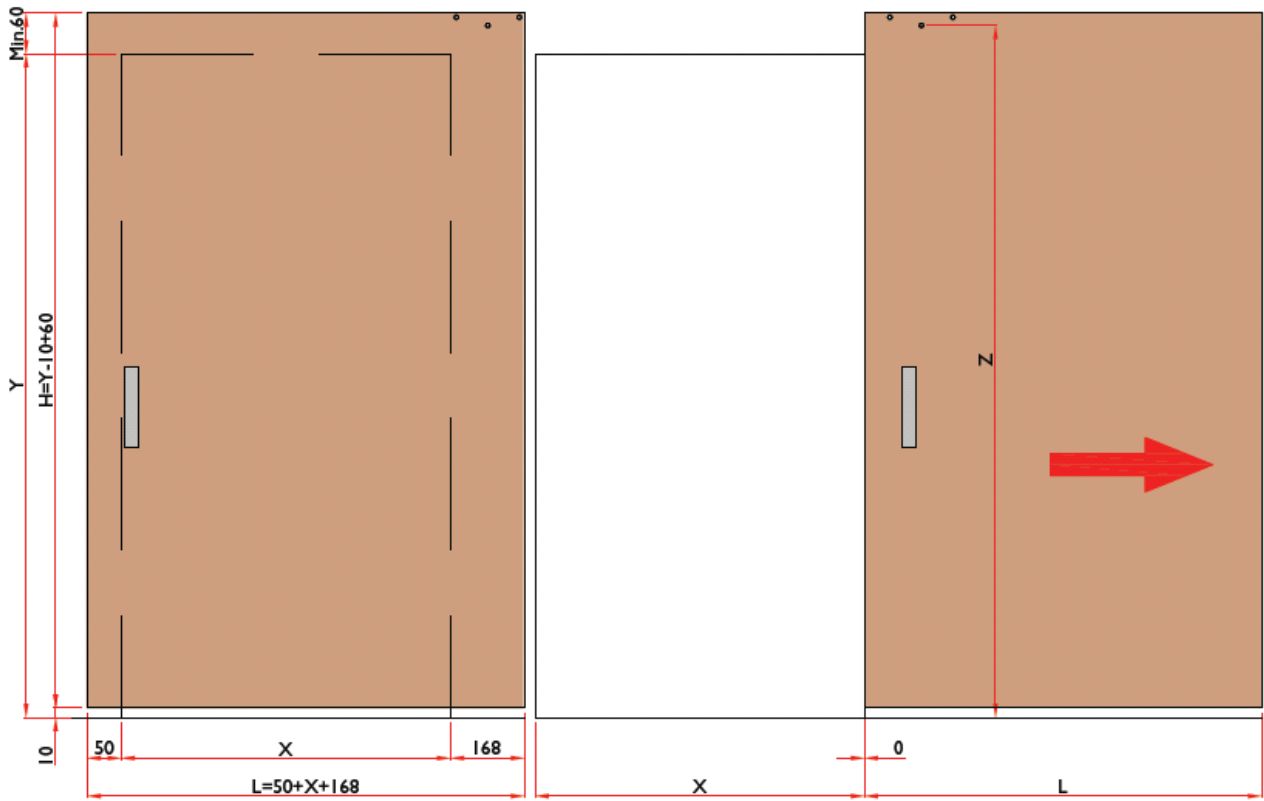

POSIZIONAMENTO PORTA
DOOR POSITIONING

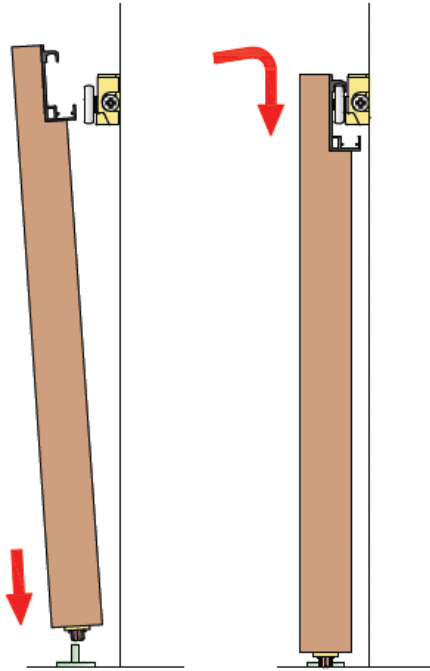

REGOLAZIONE CARRELLO
SLIDING ADJUSTMENT

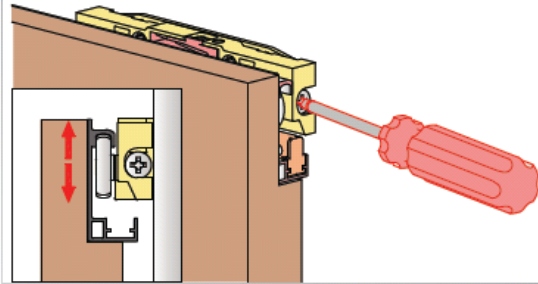

ATTIVAZIONE ANTISGANCIAIMENTO
ANTI-UNHOOKING ACTIVATION

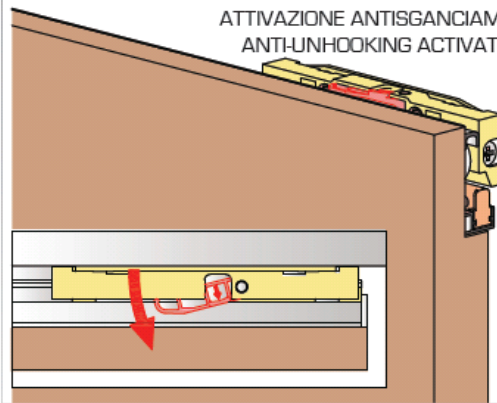

CARICAMENTO AUTOMATICO DEL FERMO AMMORTIZZATO
SELF ACTIVATING SOFT CLOSING SYSTEM

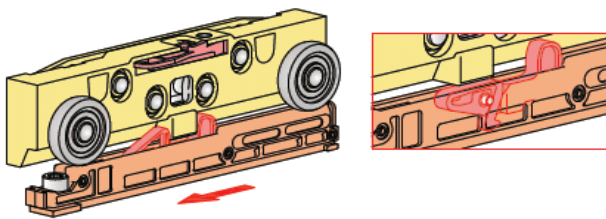

TAPPI LATERALI
LATERAL CAPS

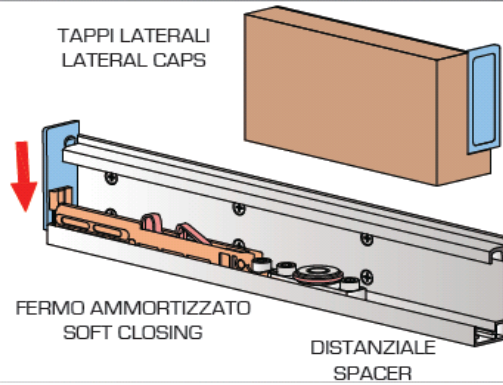

FERMO AMMORTIZZATO
SOFT CLOSING

DISTANZIALE
SPACER

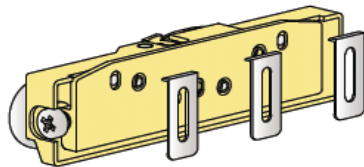

UTILIZZARE GLI SPESSORI PER COMPENSARE GLI AVVALLAMENTI DELLA PARETE
USE OF SHIMS TO COMPENSATE FOR WALL DEPRESSIONS

