



XL LOCK MANAGER

CLOUD-BASED ACCESS MANAGEMENT

A SYSTEM FOR CONTROLLED FLEXIBILITY

X LOCK

XLOCK 160BN

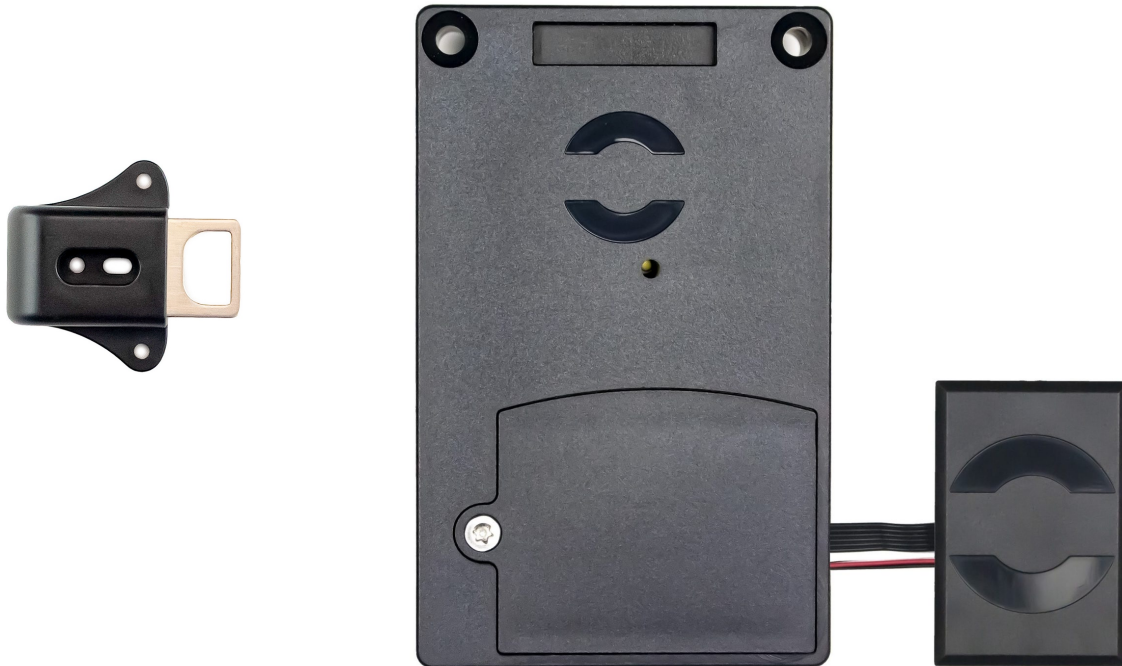

- Quick release lock
- Bluetooth & NFC (reads Mifare)
- Remote control and unlocking with Gateway (to be ordered separately)
- External NFC antenna A22
- Micro USB as an emergency power connection
- Feedback button for automatic locking
- Open/close logging
- Including lock plate S12
- Battery: 2CR5 battery (to be ordered separately)
- Incl. mounting material

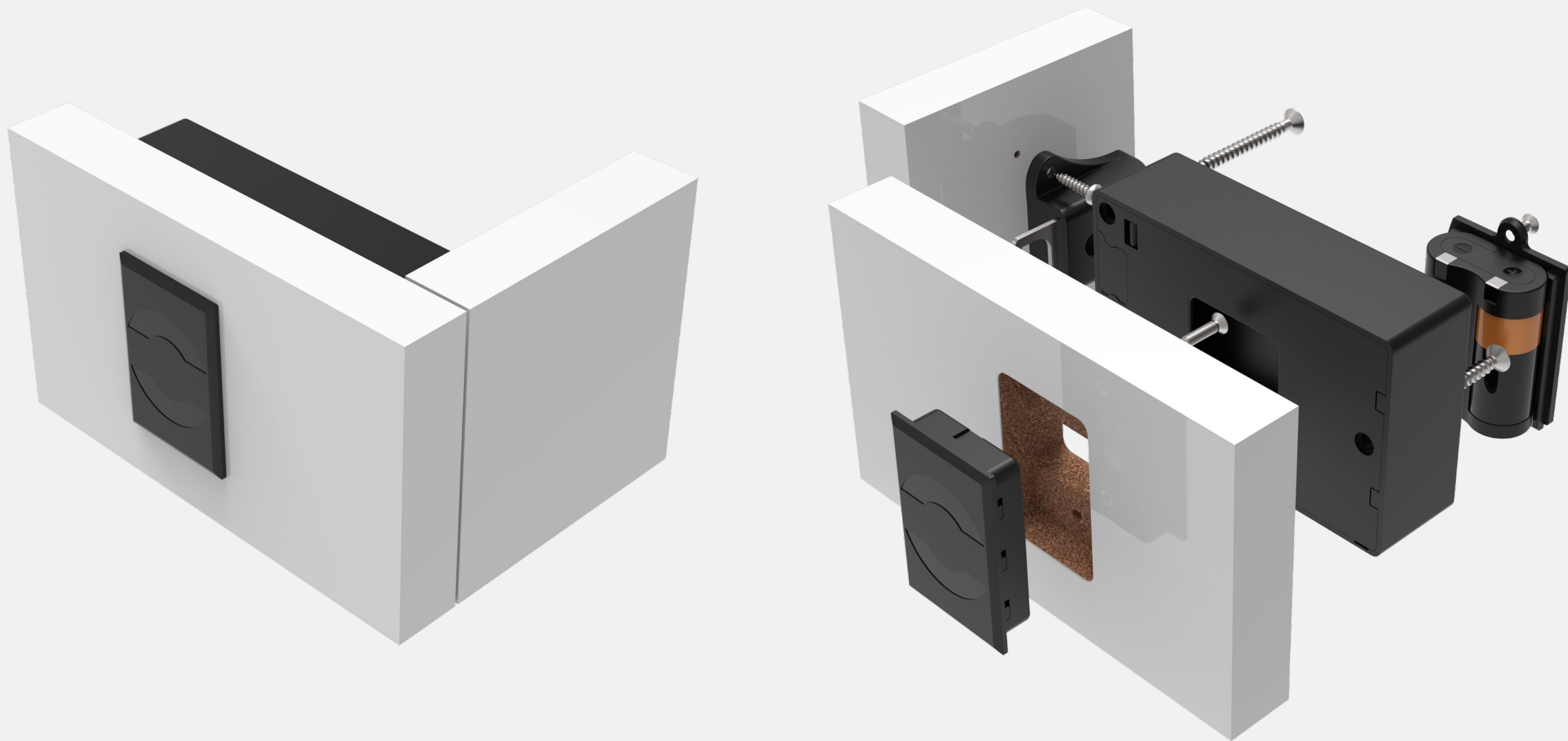

X LOCK

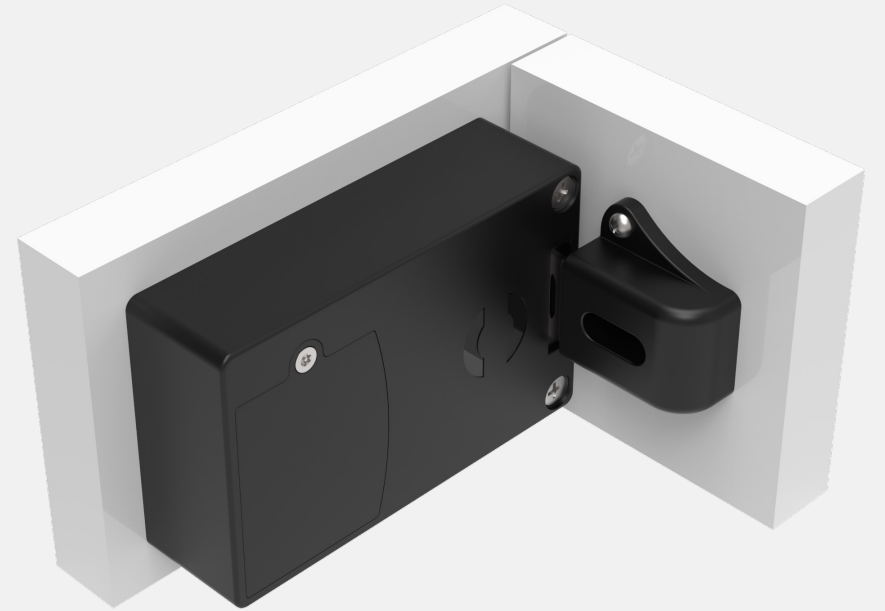
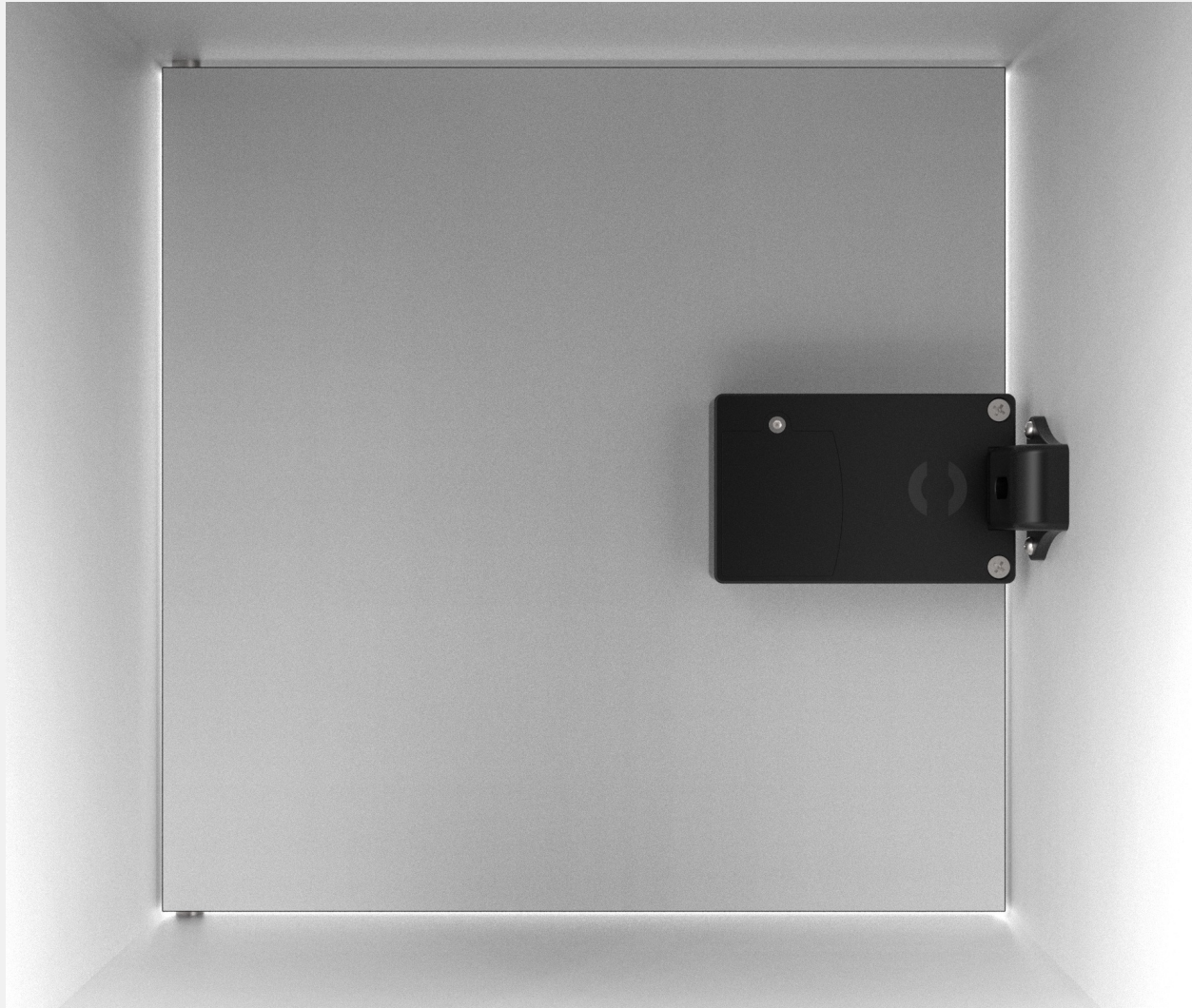

X LOCK



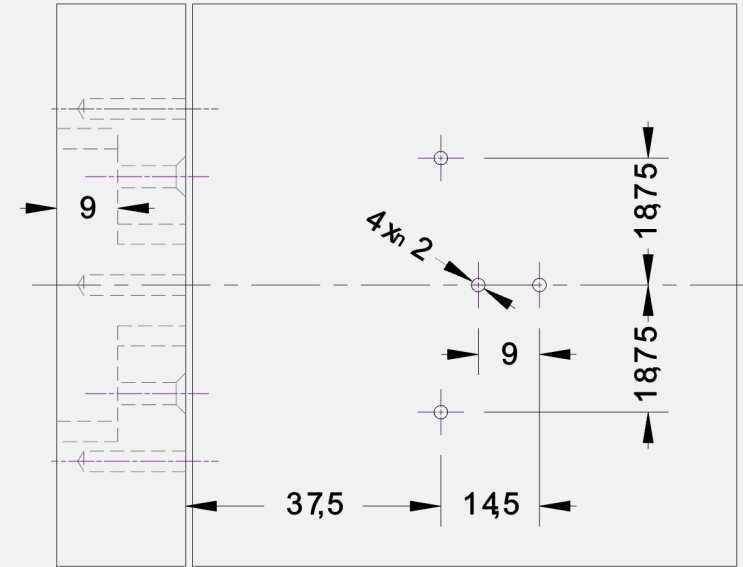
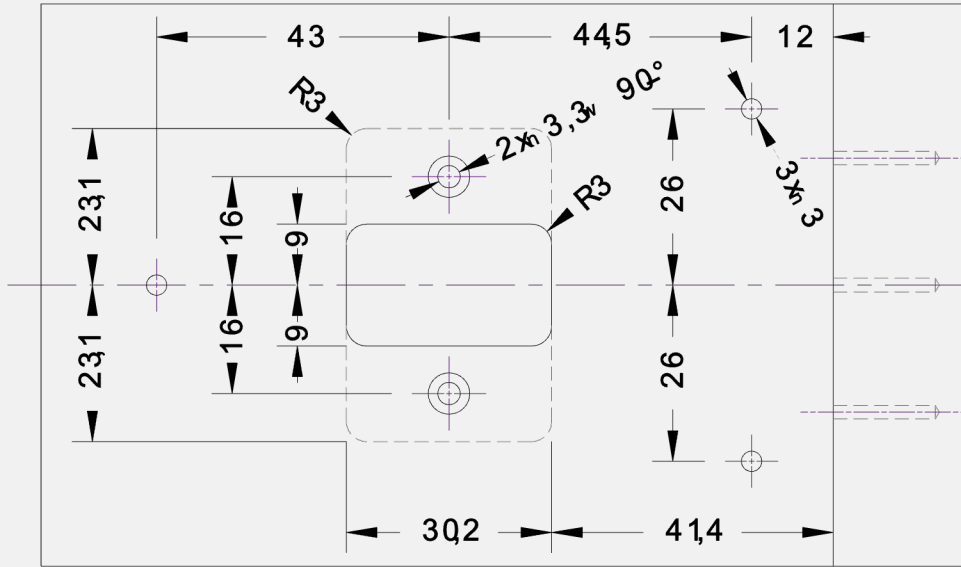

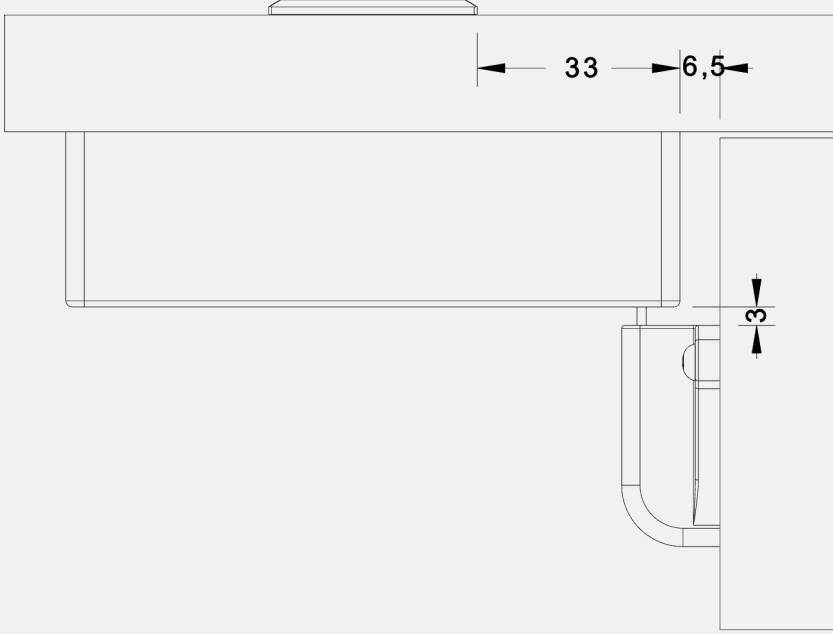
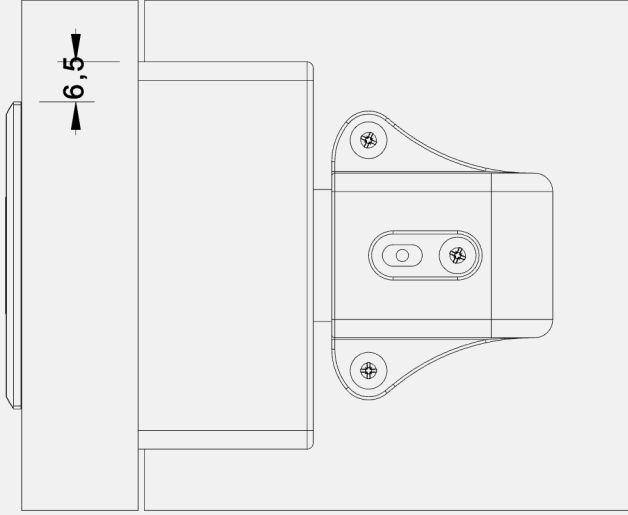
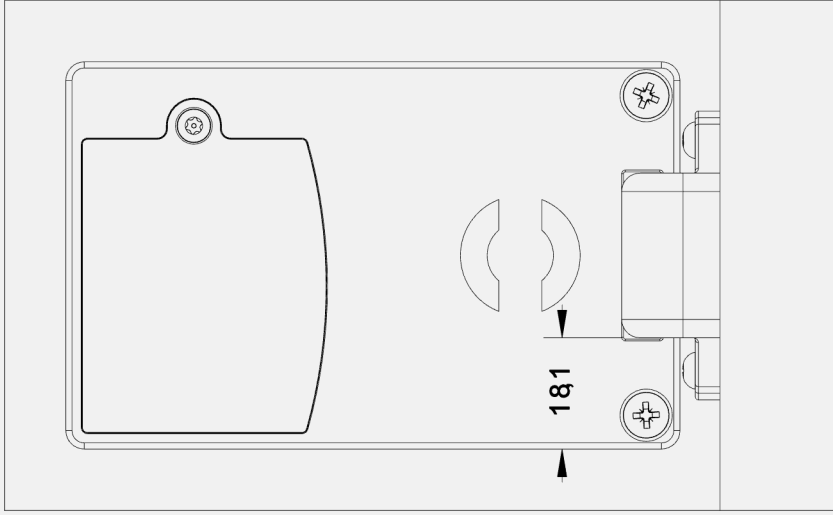

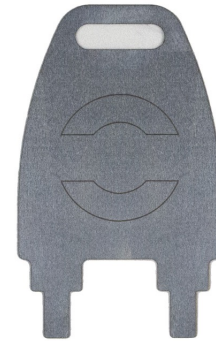

XLOCK opening tool for antenna

Access Micro USB for emergency opening (if battery was not changed in time)

X LOCK

All your keys at hand.
At anytime and from anywhere.

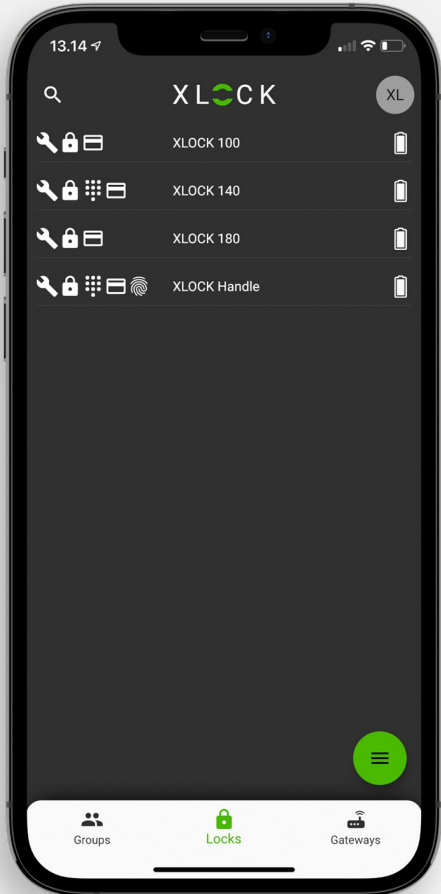

Unlock with a single swipe.

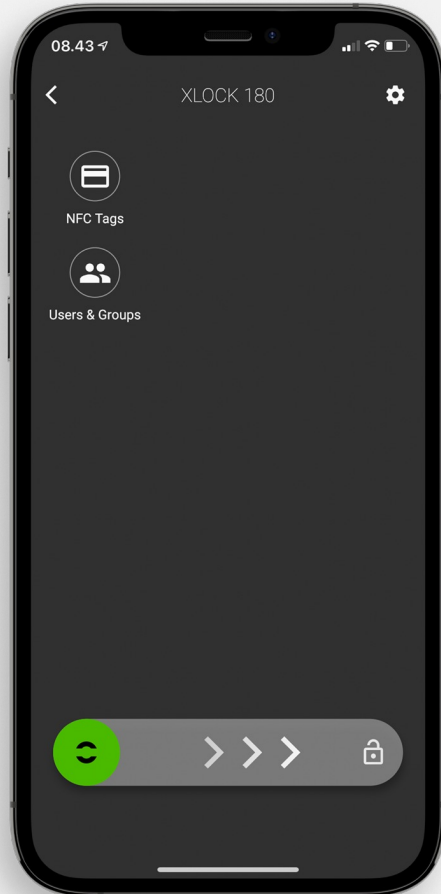

Grant, update and delete
users at anytime.

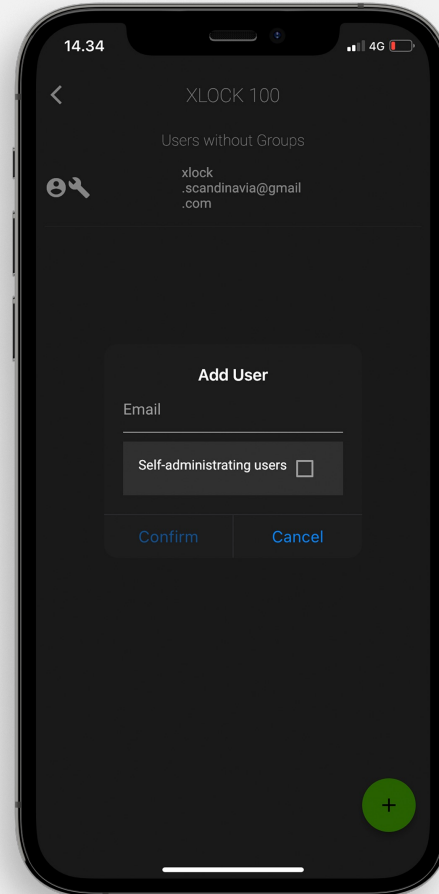

See who unlocked at what
time.

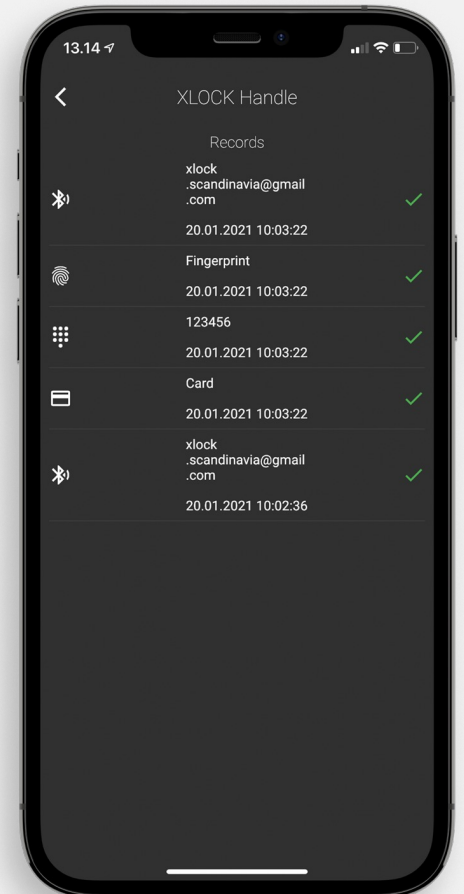

XLOCK LOCK MANAGER APP

CLOUD BASED ADMINISTRATION WITH ULTRA-FLEXIBILITY

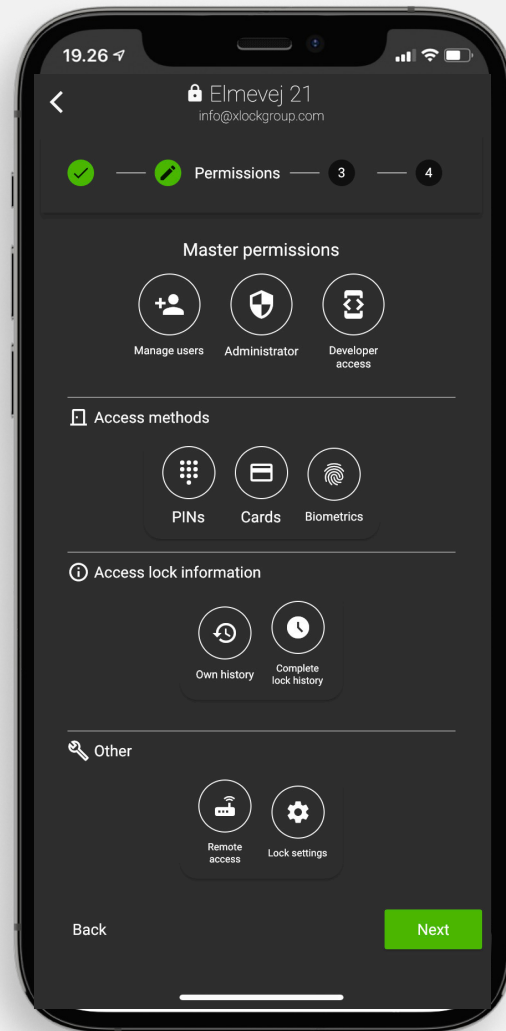

GRANT INDIVIDUAL ACCESS TO ADMINS AND USERS.

PROGRAMMING CARD DIRECTLY FROM YOUR SMARTPHONE

FROM ANYWHERE AT ANY TIME (GATEWAY REQUIRED)

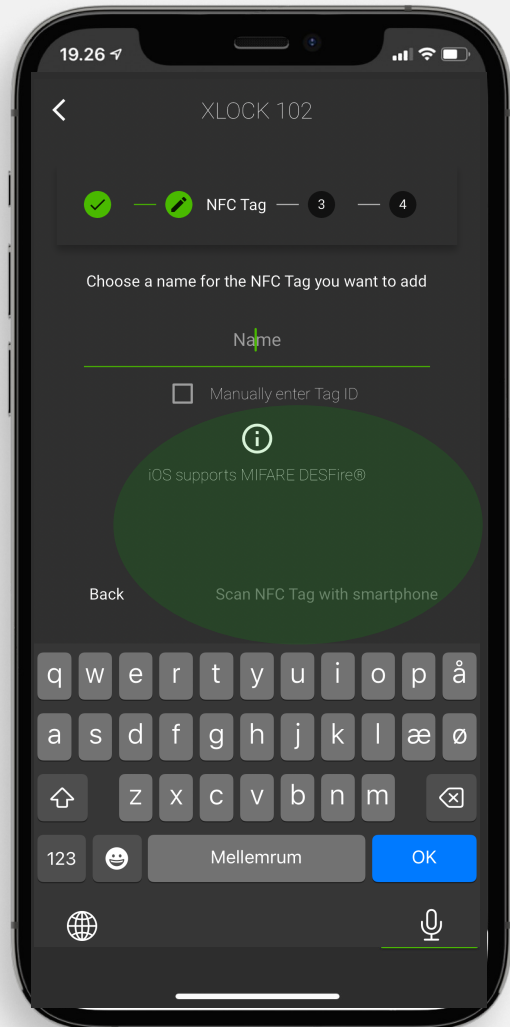

NO OTHER PROGRAMMING DEVICE NEEDED.

Use your smartphone to scan your card's ID.

- iOS supports MIFARE DESFire
- Android supports MIFARE DESFire and MIFARE Classic

With just a few clicks you can program a card to your lock(s)
– even on the go.

GROUP UNLOCKING

**UNLOCK A WHOLE GROUP OF LOCKS
WITH ONE SWIPE.**

Have a wall of lockers or an area with several locks?
Then this feature is a must for your site!

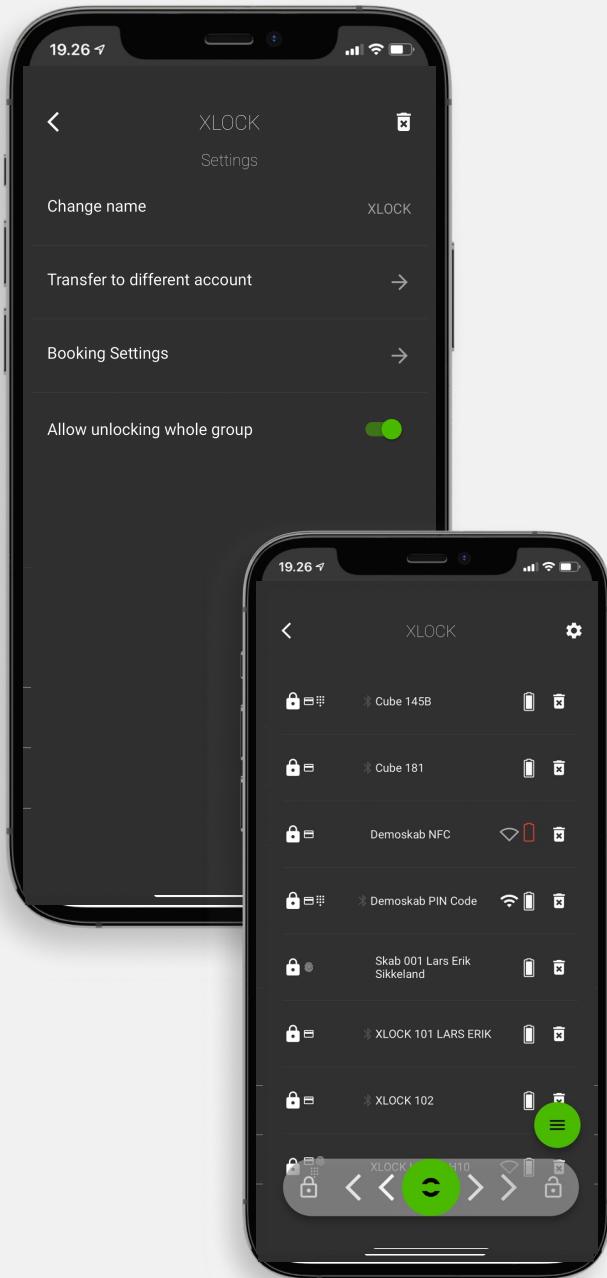

MAINTENANCE REMINDER

GET A REMINDER TO SWITCH BATTERIES.

Via any Bluetooth action the battery status will be updated in the XL Lock Manager App.

If the batteries have less than 30% remaining, you will get an E-Mail sent with detailed information.



Maintenance reminder

These devices may be in need of attention soon:

- Lock name 1**
Battery at 5%
- Lock name 2**
Battery at 15%
- Lock name 7 very long here**
Battery at 30%

You can retrieve the current status inside the XL Lock Manager app.

Best Regards,
the XLOCK-Team

Need help? Drop us a message at info@xlockgroup.com or visit us on www.xlockgroup.com

XLOCK by data mobile / Thomas Vogler
Landstrasse 35-39
6911 Lochau
Austria

ADMIN DASHBOARD

OVERVIEW ON BATTERY STATUS

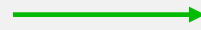

AND LOCK USAGE.



- Overview
- Battery**
- Lock Usage
- Gateways
- Booking Groups

Admin Dashboard - Beta

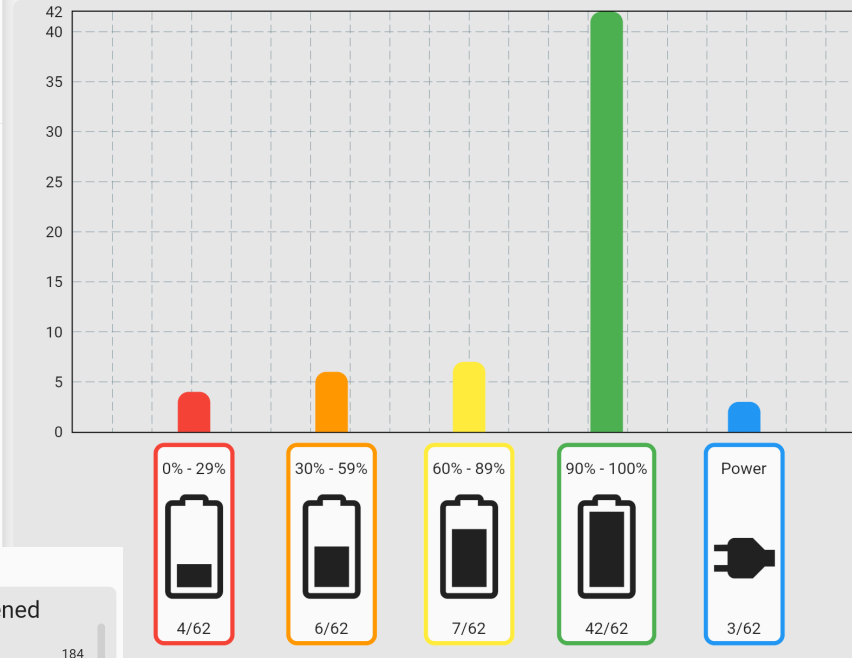

Locks between 90% - 100% battery

- Cube 145B - 100%
Building 1 - Zone 1
- Cube 181 - 100%
Building 1 - Zone 1
- Demoskab PIN Code - 100%
Building 1 - Zone 1
- Elmevej 21 - 100%
- Elmevej 21 Havelå - 95%
- Elmevej 21 NEW - 100%
- Elmevej skur - 92%
- Haus 35 - Heizung / Server - 100%
Building 1 - Floor 1
- Haus 35 - Lager (14.8.23) - 100%
Default Gebäude - Default Gebäude



Admin Dashboard - Beta

Lock Usage

- 24 hours
- 7 days
- 31 days**

Locks Opened

Elmevej 21 NEW	184
Elmevej skur	27
Polensgade 19	20
Elmevej 21 Havelå	4
SØVANG SPORTSKLUB HOVEDINDGANG	2
Bikelock S showroom	0
Cube 145B Building 1 - Zone 1	0
Cube 181 Building 1 - Zone 1	0
Demoskab NFC Building 1 - Zone 1	0
Demoskab PIN Code Building 1 - Zone 1	0

Select lock

All 237	Bluetooth 17	Card 14	Fingerprint 195	PIN 11	Gateway 0
------------	-----------------	------------	--------------------	-----------	--------------

WEB INTERFACE:

www.xlock.app

REAL TIME MONITORING – WHO ACCESSED AT WHAT TIME?

REMOTE CARD PROGRAMMING AND DELETING.

ADMINISTRATE YOUR LOCKS FROM ANYWHERE.

SMART MAINTENANCE. BATTERY STATUS MONITORING
TO ENSURE PRO-ACTIVE MAINTENANCE.

SAVE MONEY AND TIME ON ORDERING NEW
KEYS, KEY FOBs AND CARDS.

NO MORE PHYSICAL KEY HANDOVER NEEDED.

CONTROLLED ACCESS TO TEMPORARY USERS.

NO RUNNING COSTS FOR THE APP – ONE TIME FEE ONLY.



! Every user gets a custom key for each lock

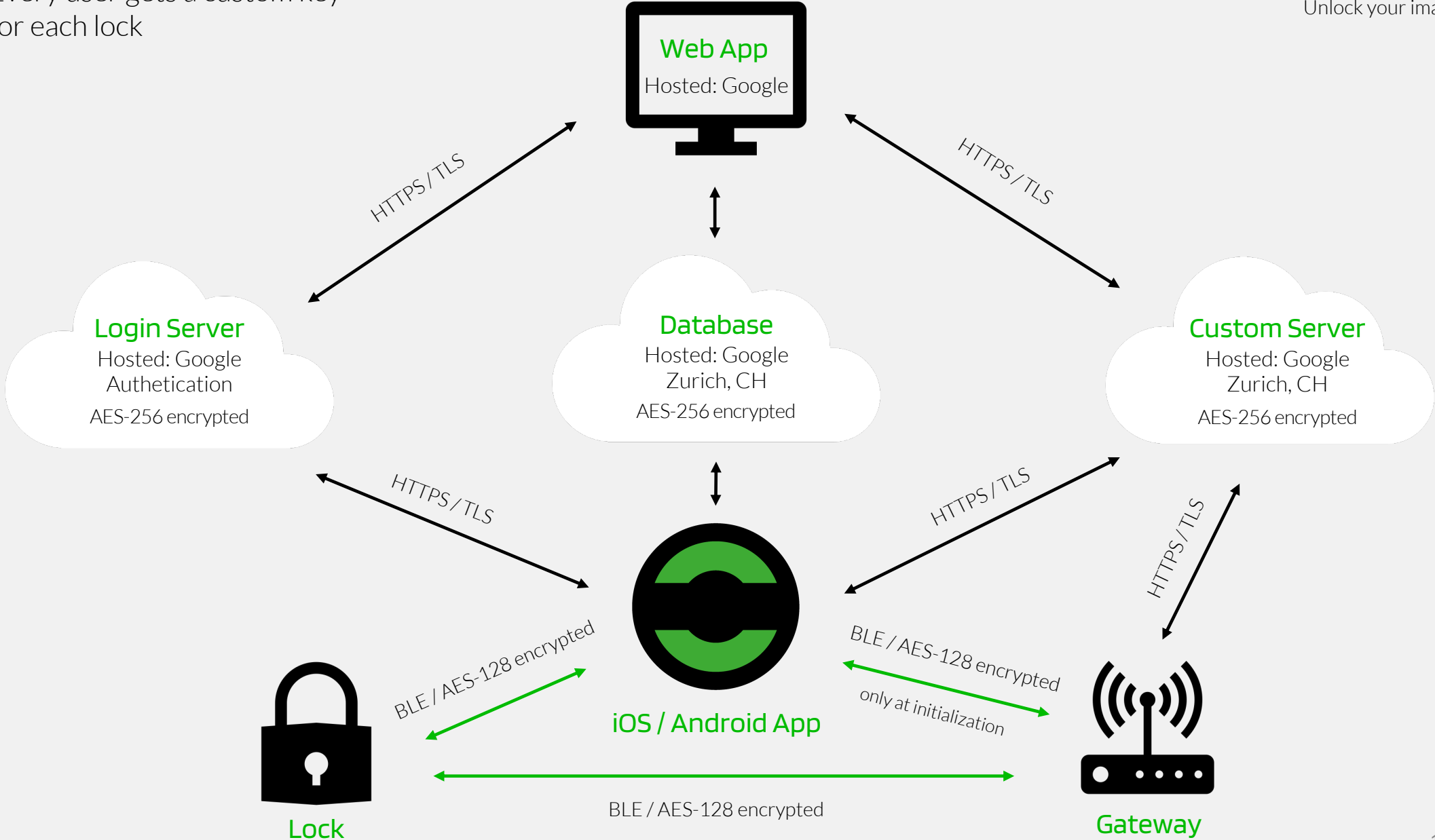

XLOCK BOOKING TOOL

TEMPORARY STORAGE
MEETING ROOMS
LOCKER MANAGEMENT
SHARED SPACES
AND MUCH MORE

book iT



X LOCK

book iT by XLOCK is a cloud-based locker management tool within the XL Lock Manager App, developed in Austria. It is simple for users to control and ideally suited to agile working environments.

It works wirelessly via Bluetooth connecting the battery operated XLOCK furniture lock to a smartphone.

Locker users engage with the quick and easy self-service XL Lock Manager App to book a locker which becomes immediately available for use. The booking can be done at the office, in the train on the way to work or from home.

Minimal administration is required enabling companies to focus on the important areas of their business.

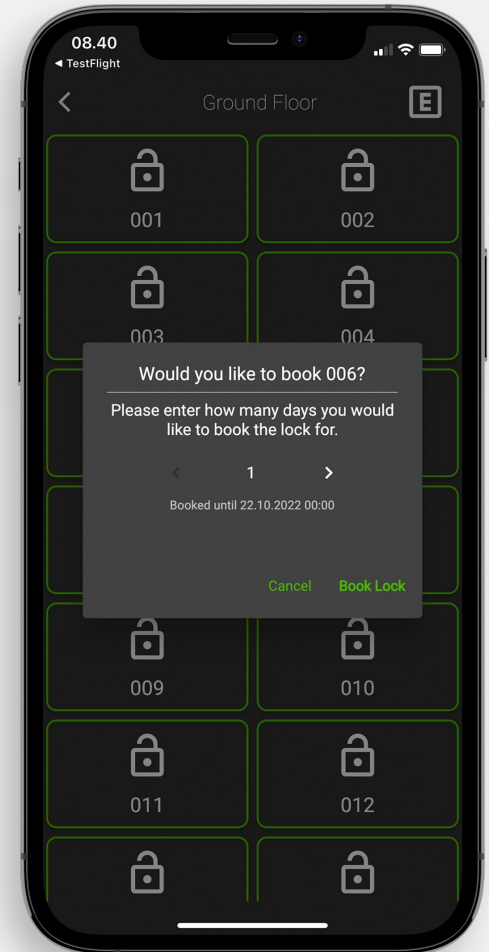

In the groups tab, available lockers are organised into Buildings and Floor/Zones/Areas.

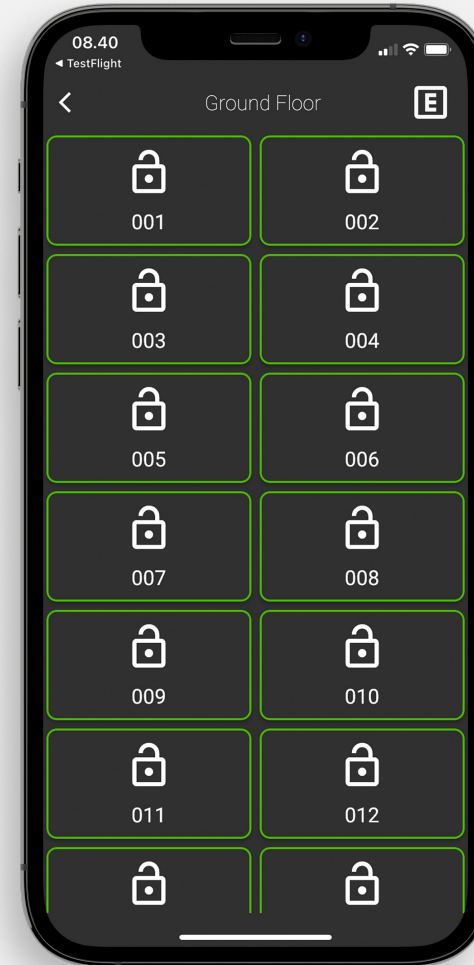
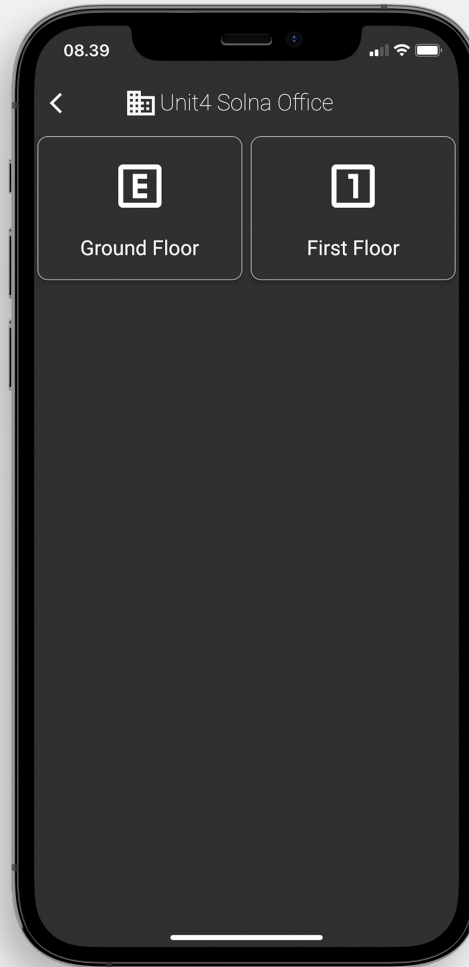

User selects locker and confirms booking – the locker is then immediately available for use.

User find the booked locker by the locker numbers on the locker.

Once booked, the locker appears on the user's "Locks" tab.



User clicks on the locker and the unlock screen appears.

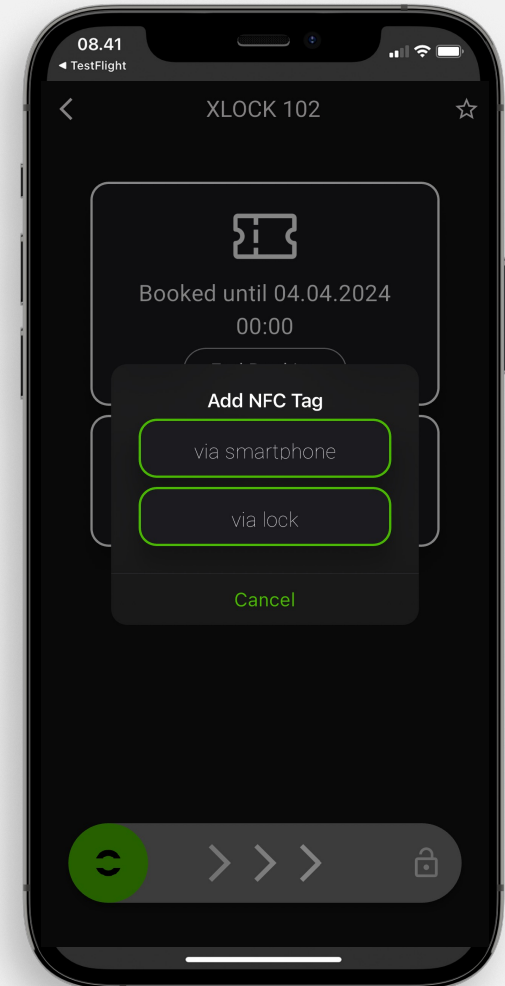
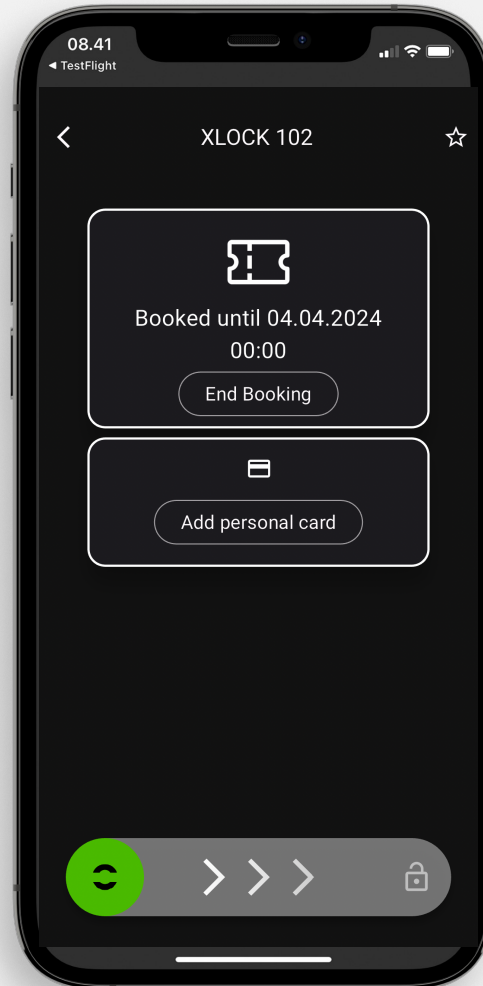

ADMIN DASHBOARD

OVERVIEW ON BOOKING GROUPS →

AND THEIR LOCK USAGE.



- Overview
- Battery
- Lock Usage
- Gateways
- Booking Groups**

Admin Dashboard - Beta

Booking Groups: Unit4 Solna Office

Use All Buildings: 13/180

Unit4 Solna Office: 13/180

Use All Zones: 13/180

Current Bookings

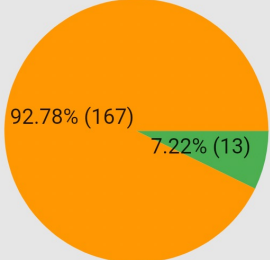

- Booked
- Available

Booked Locks

- 011
- 013
- 027
- 028
- 062

Admin Dashboard - Beta

Lock Usage

24 hours | 7 days | **31 days**

Select lock

All: 98

Bluetooth: 98

Card: 0

Fingerprint: 0

PIN: 0

Gateway: 0

Locks Opened

132	Unit4 Solna Office - First Floor	21
134	Unit4 Solna Office - First Floor	15
013	Unit4 Solna Office - Ground Floor	6
063	Unit4 Solna Office - Ground Floor	6
131	Unit4 Solna Office - First Floor	6
028	Unit4 Solna Office - Ground Floor	5
126	Unit4 Solna Office - First Floor	4
130	Unit4 Solna Office - First Floor	4
011	Unit4 Solna Office - Ground Floor	3

- Overview
- Battery
- Lock Usage**
- Gateways
- Booking Groups

WEB INTERFACE:

www.xlock.app

XLOCK Gateway



Install a Gateway within Bluetooth range to your locks, connect it to your WIFI and you are ready to go.

A Gateway is the right accessories if you are looking to save a lot of time on administration. Programming RFID cards and unlocking your locker remotely are just a few of the smart features that will make your life easier.

Different versions available:

- Wifi
- POE
- Ethernet
- GSM



X LOCK



XLOCK GmbH

Landstrasse 35-39

AUT-6911 Lochau

info@xlockgroup.com