

MC 5M - MC 6P - MC 7P

Instructions for use

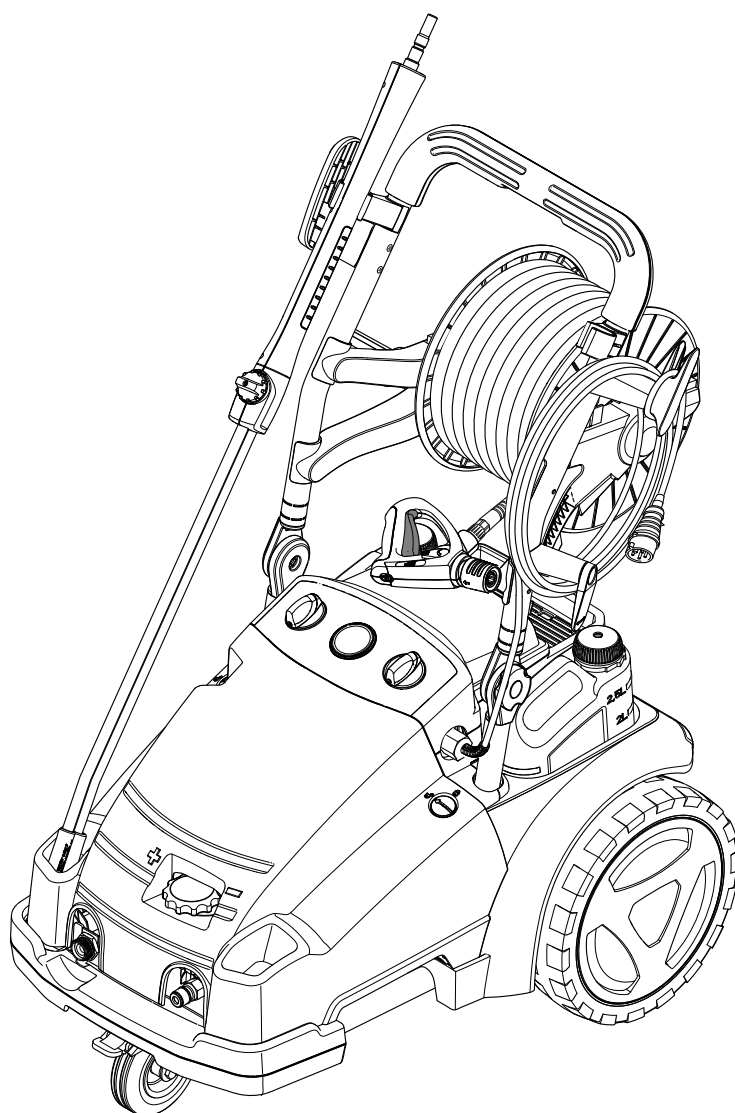

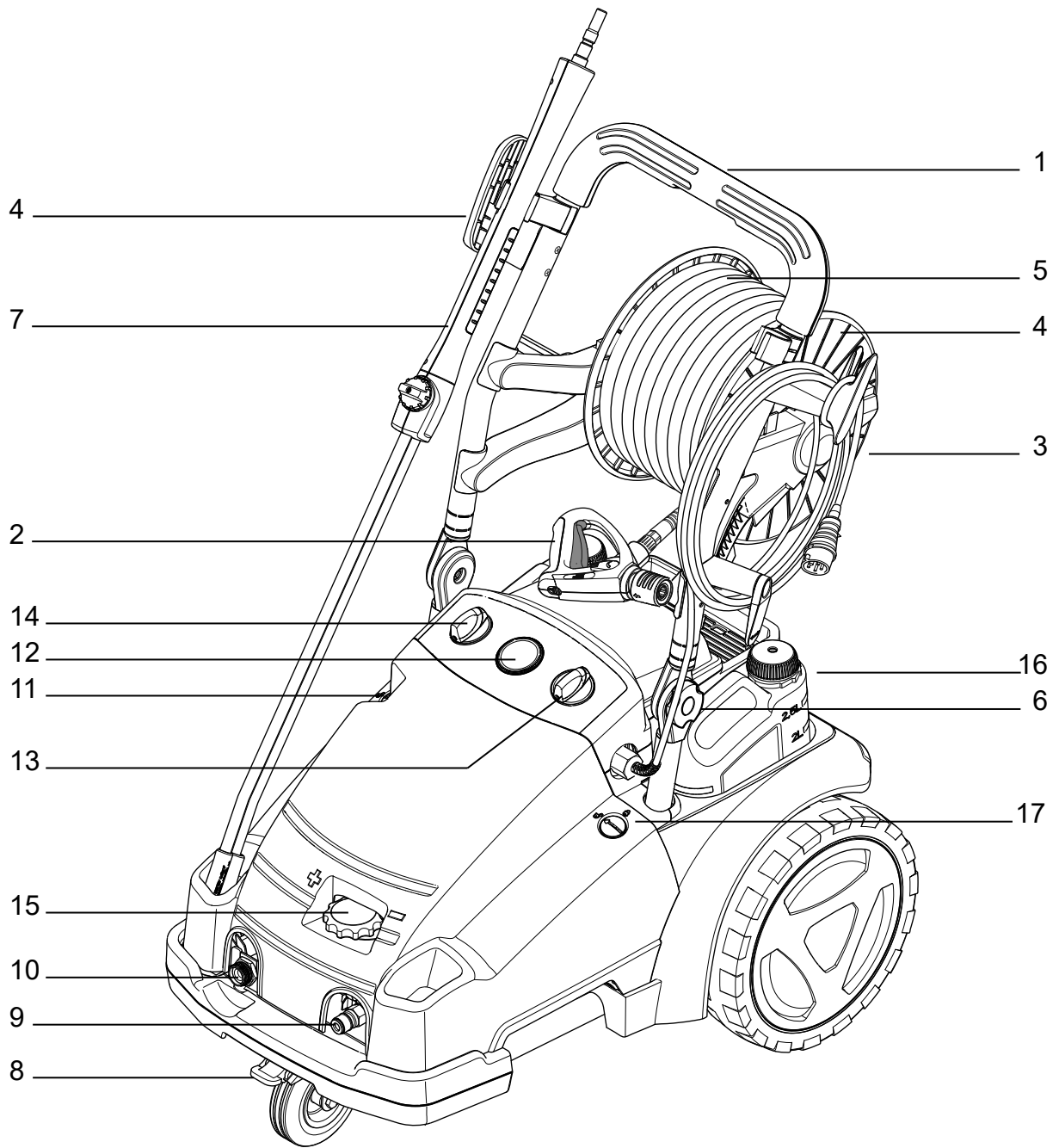

B1

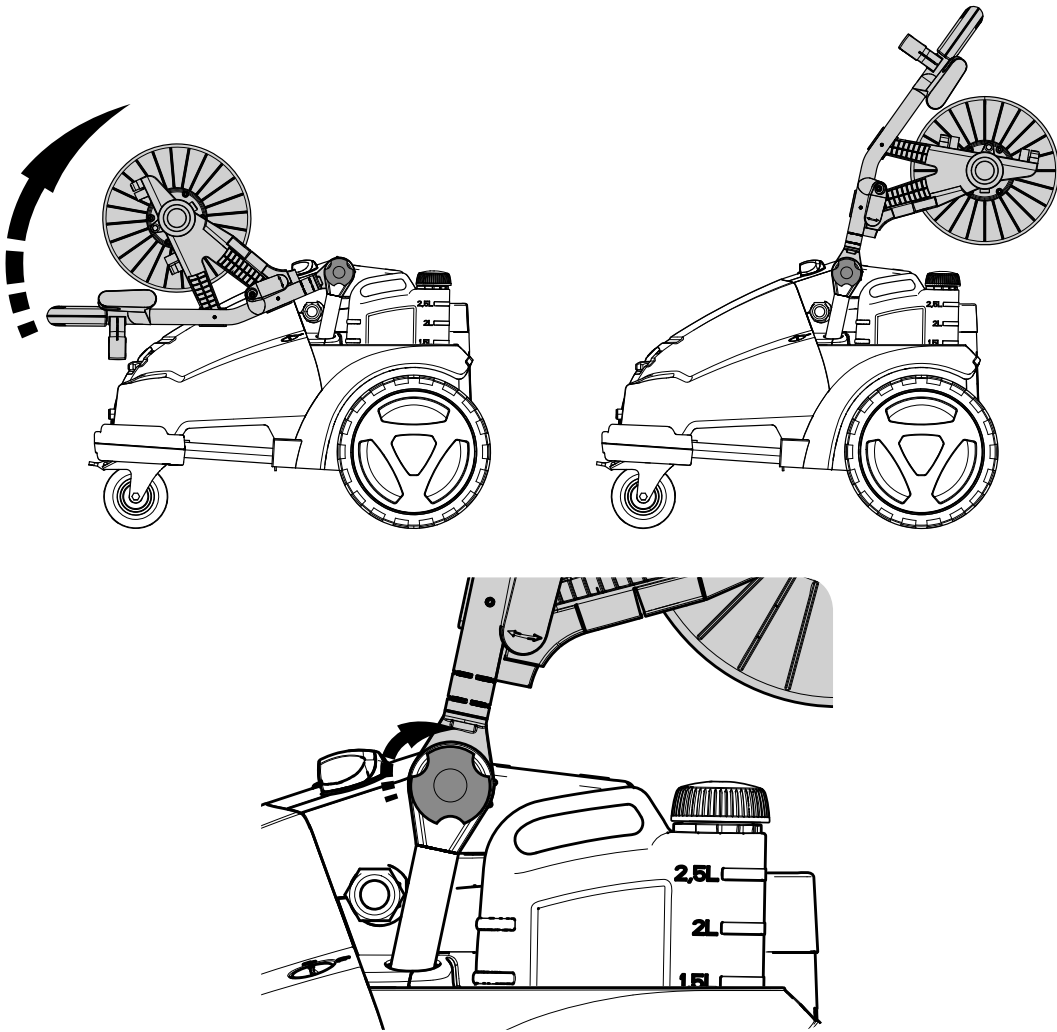

C1

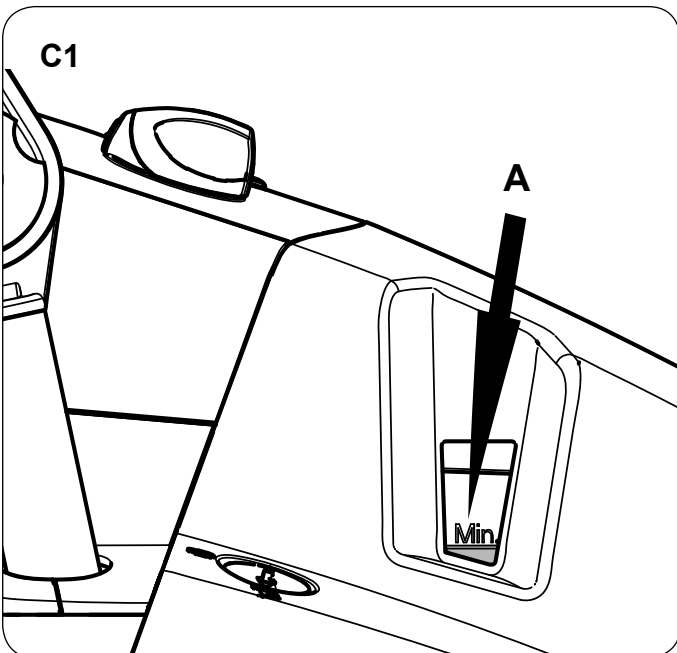

C2

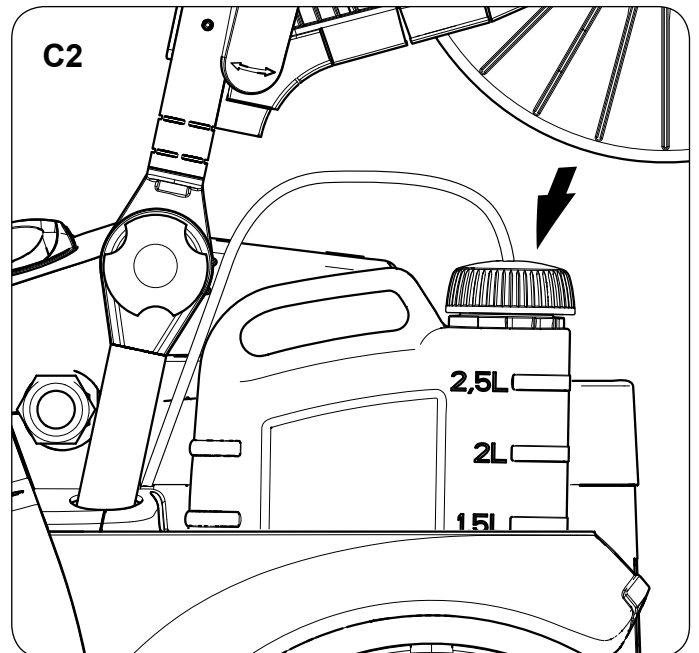

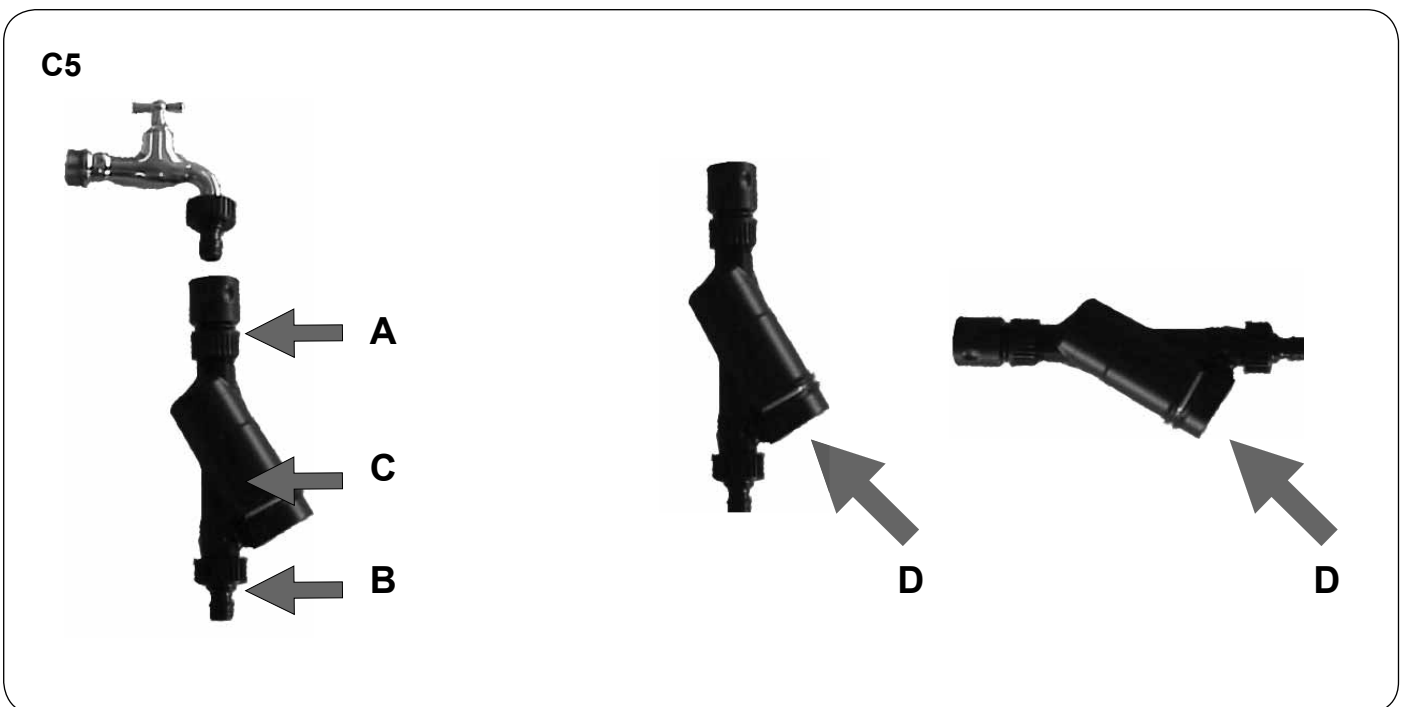
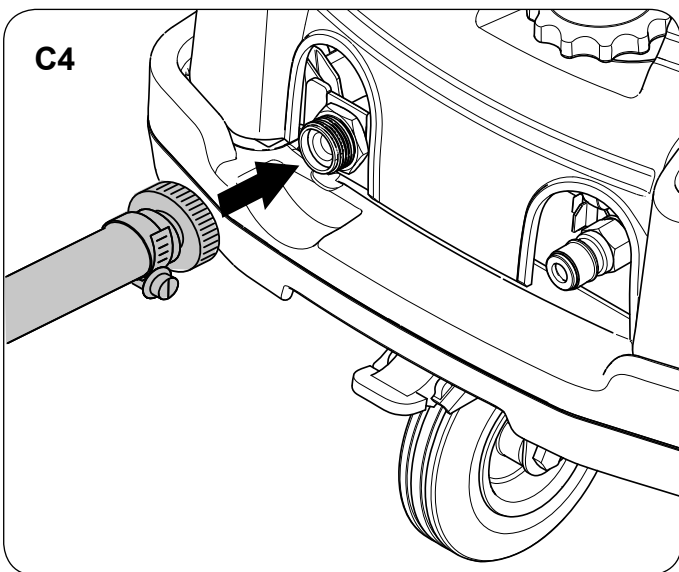
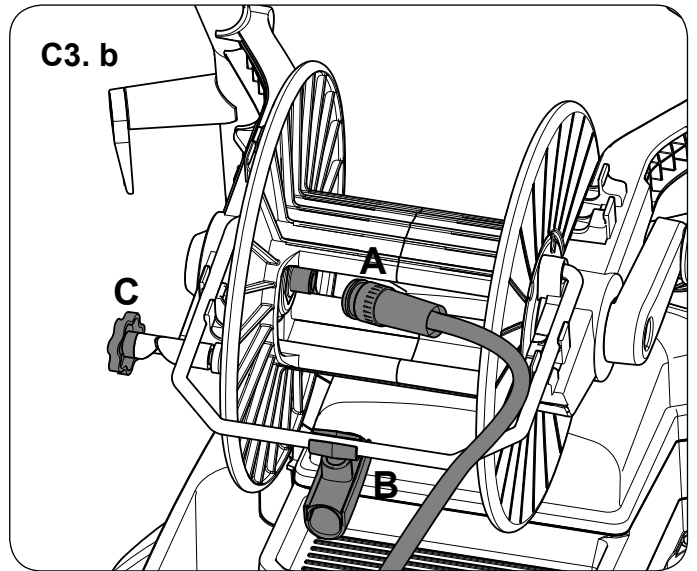
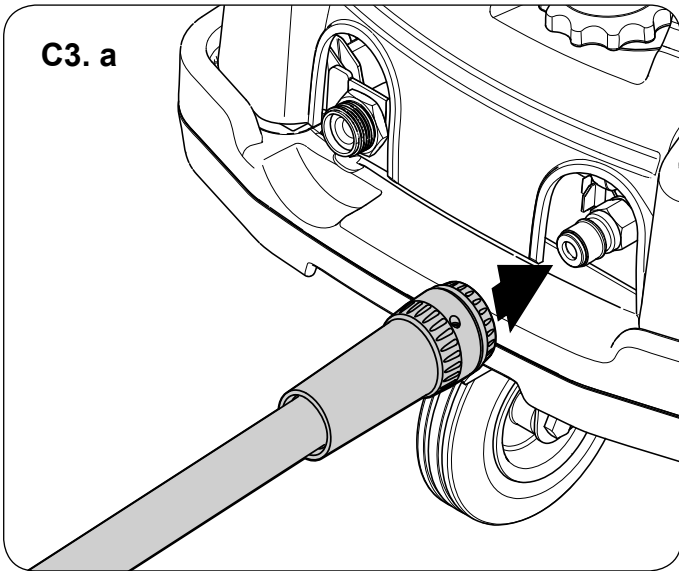

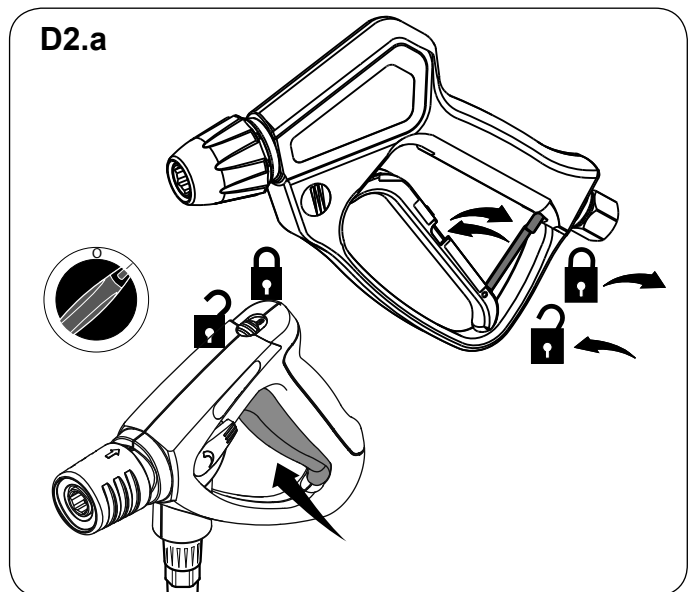
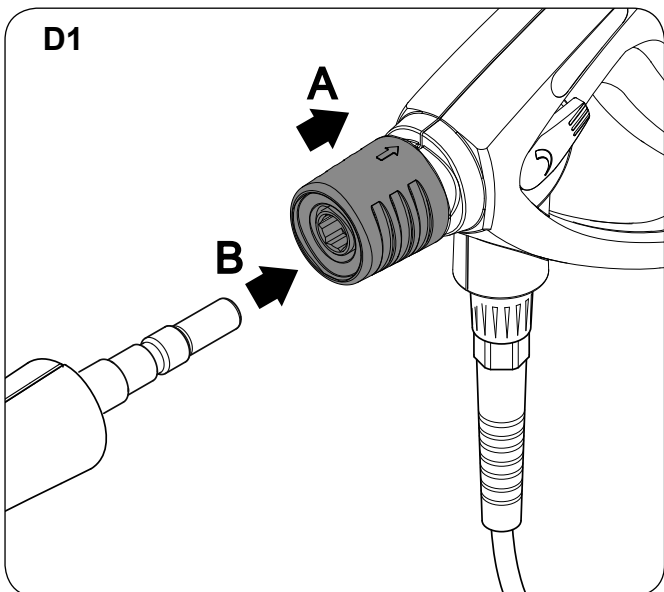
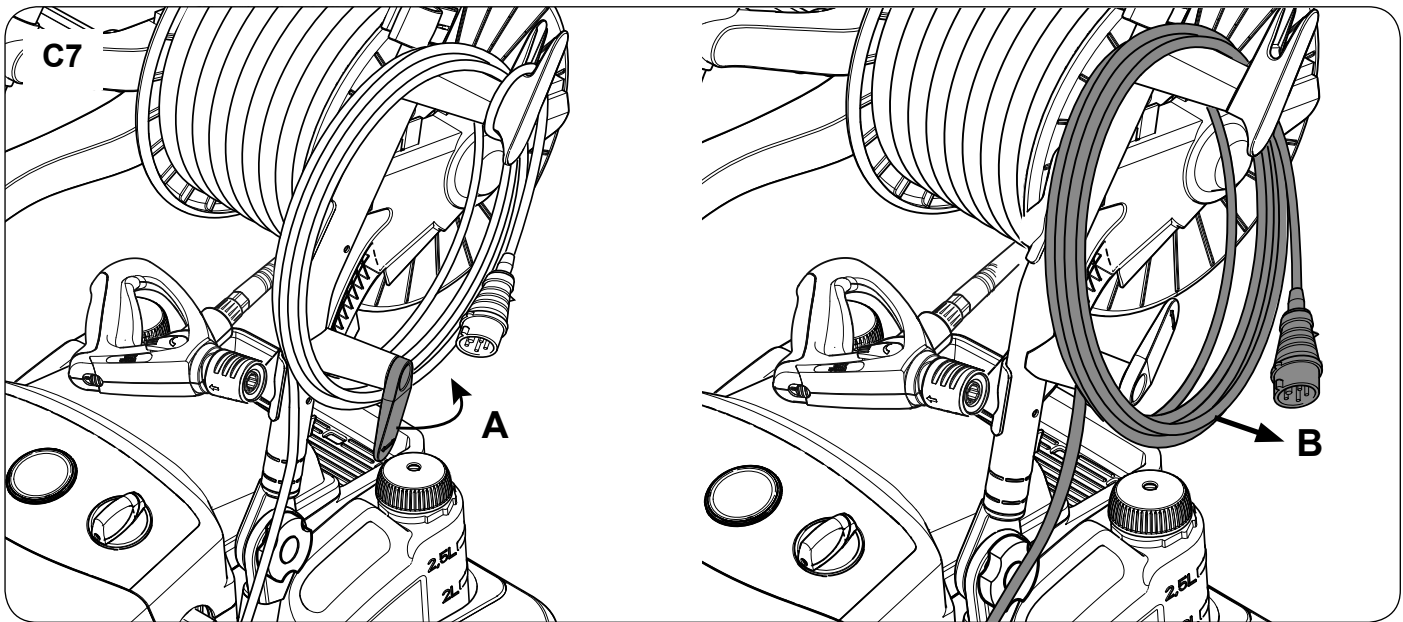
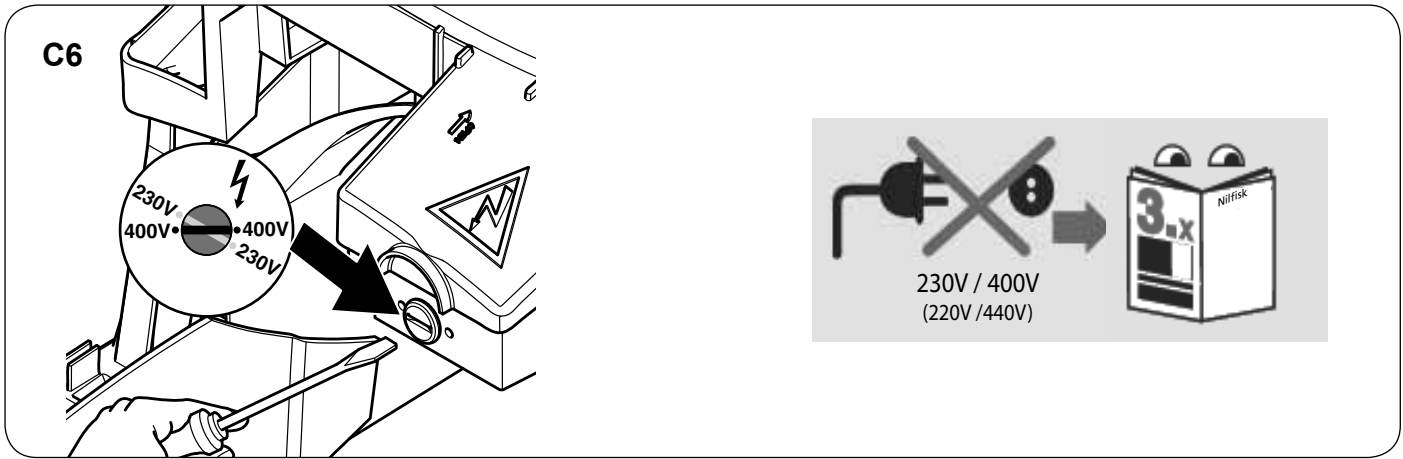

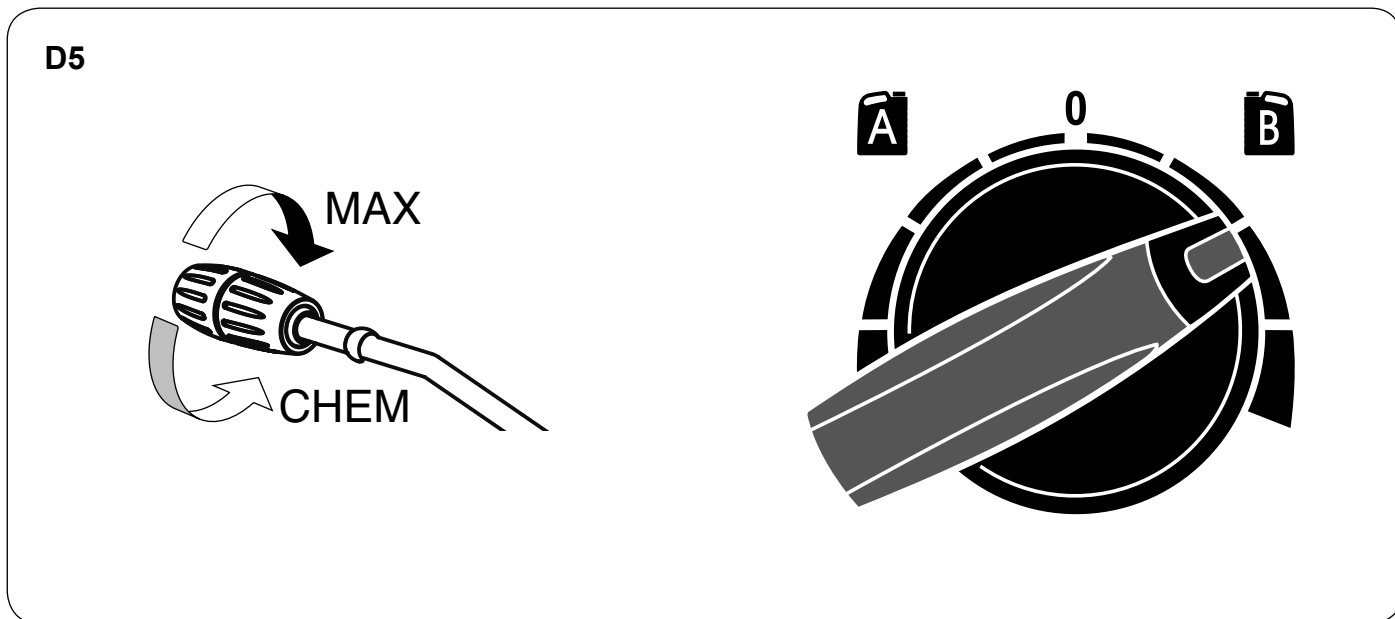
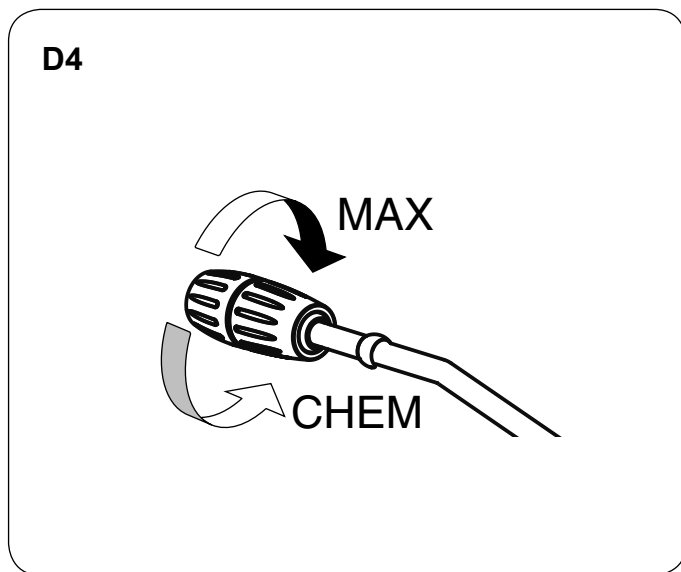
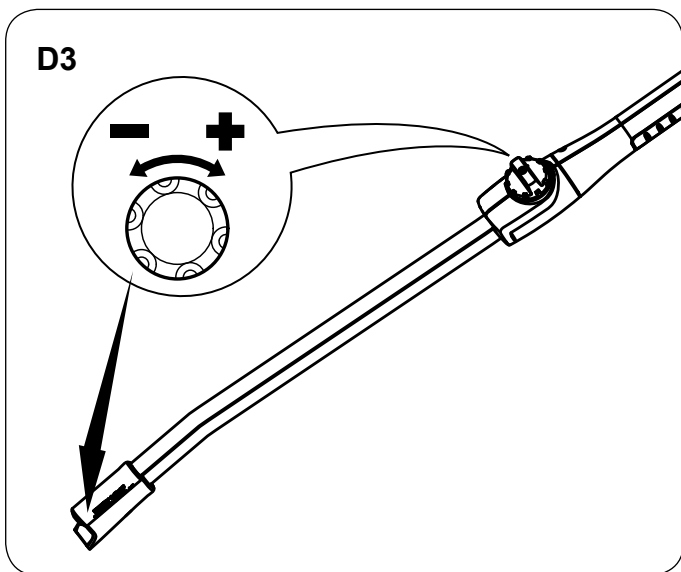
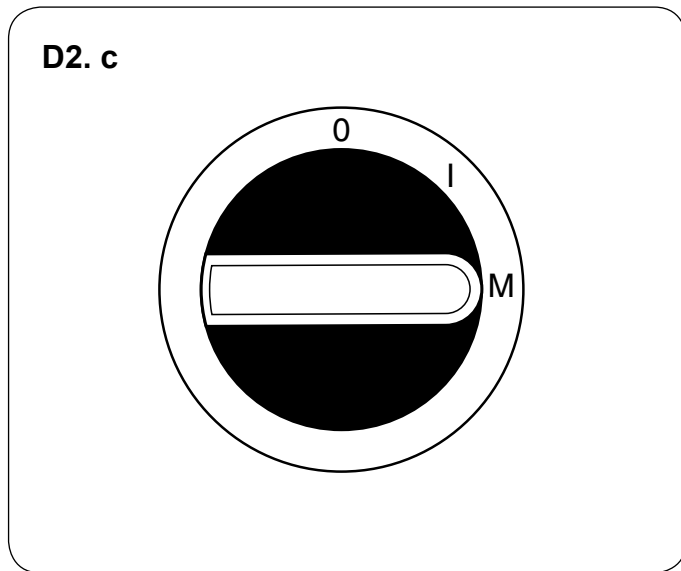
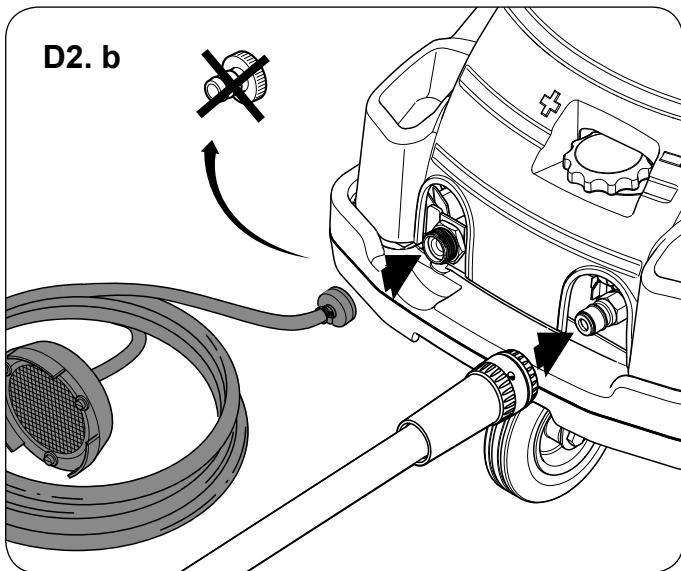

E1

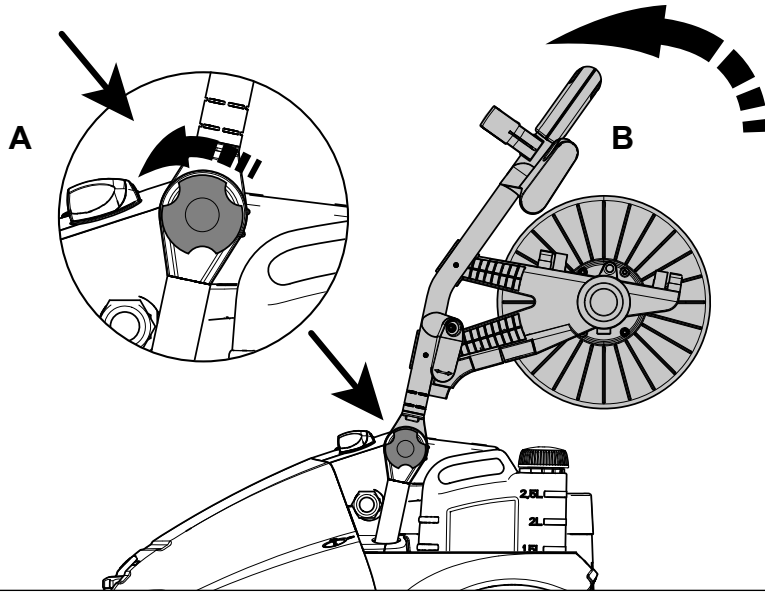

E2

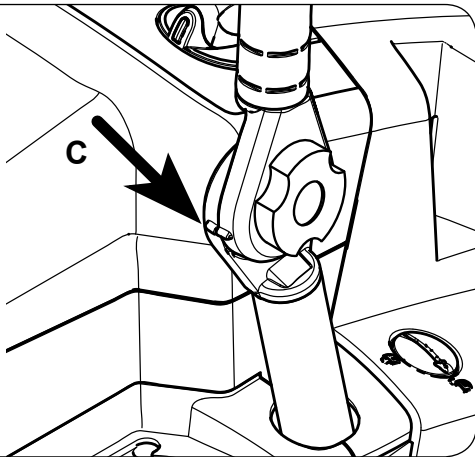

E3

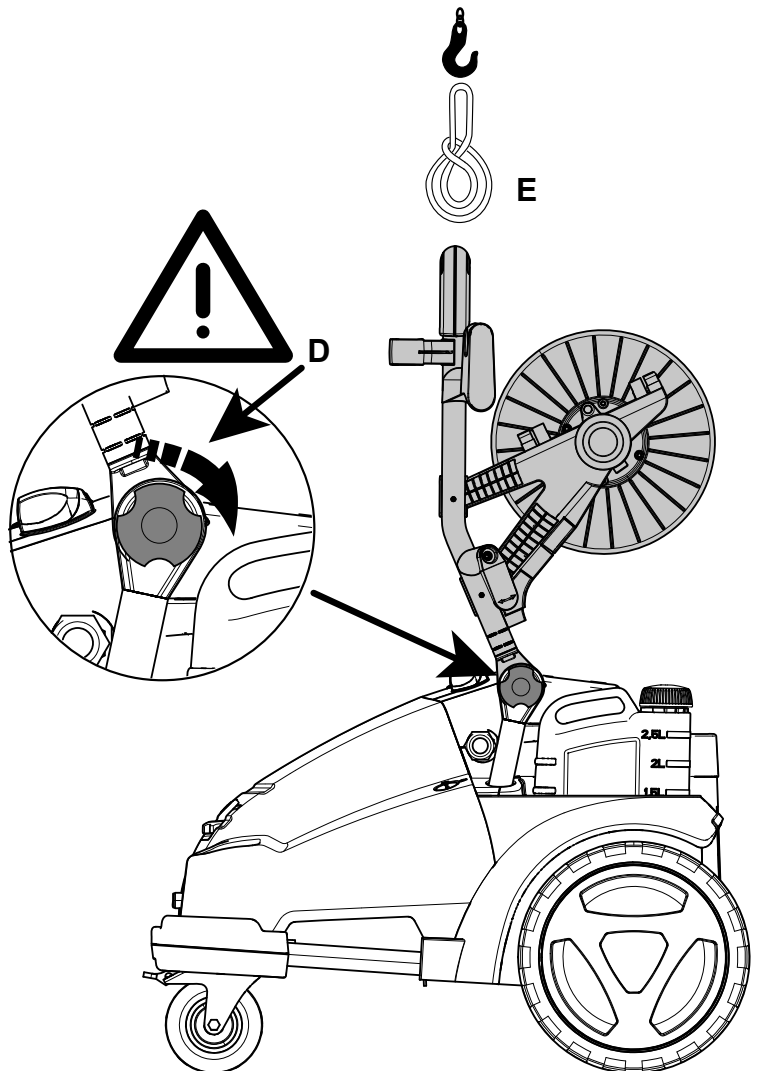

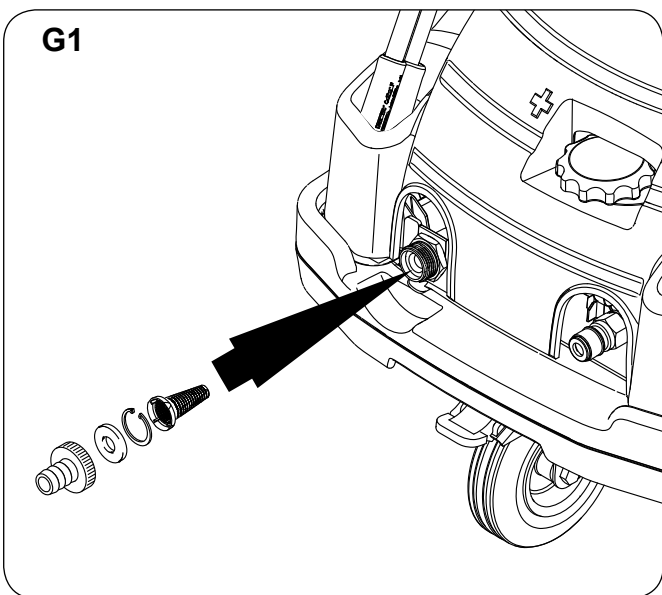
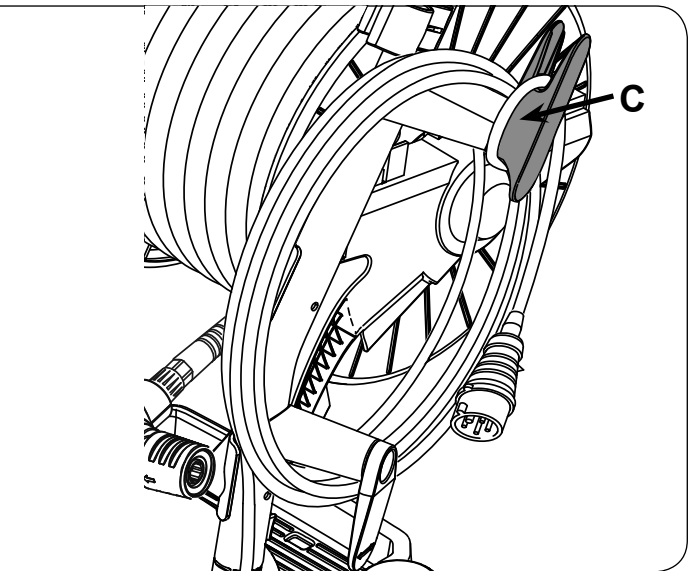
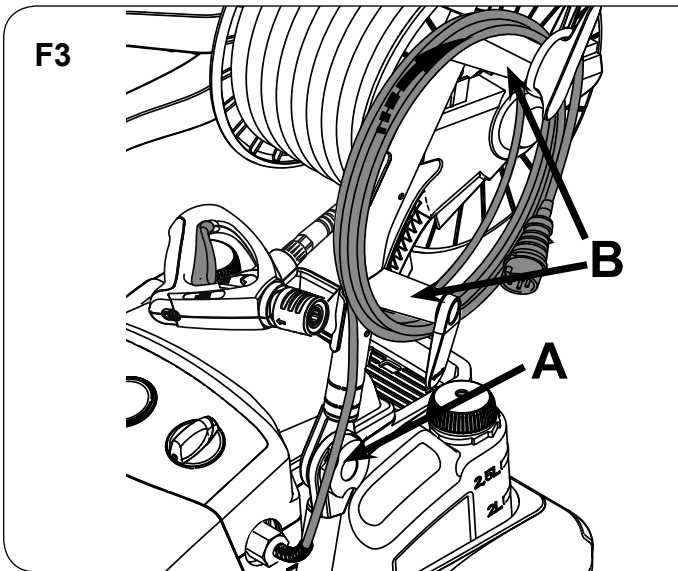
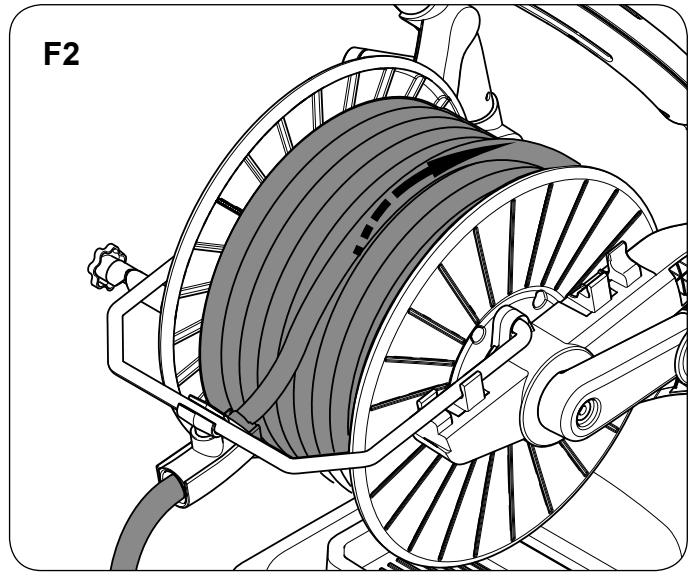
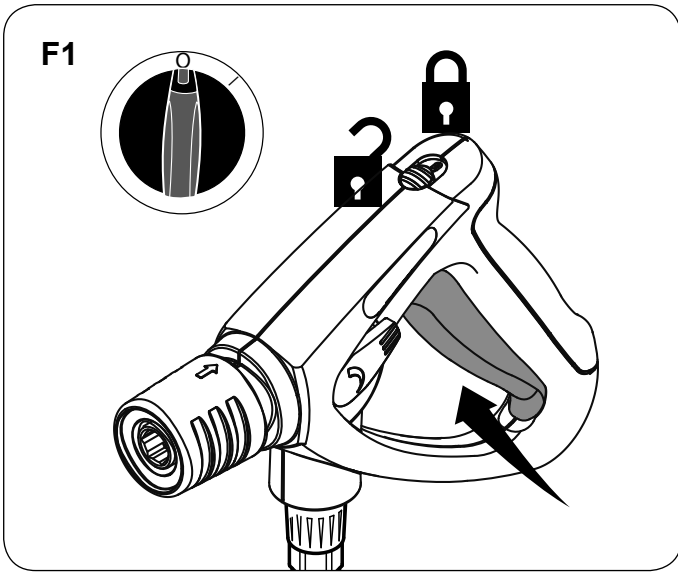

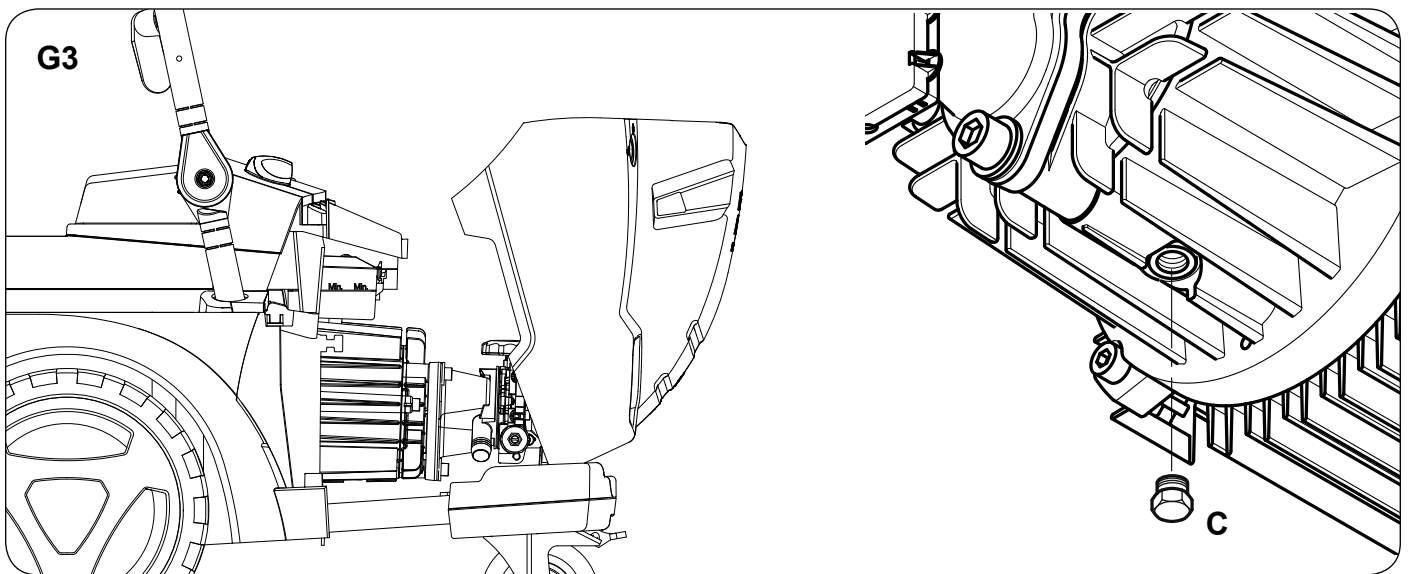
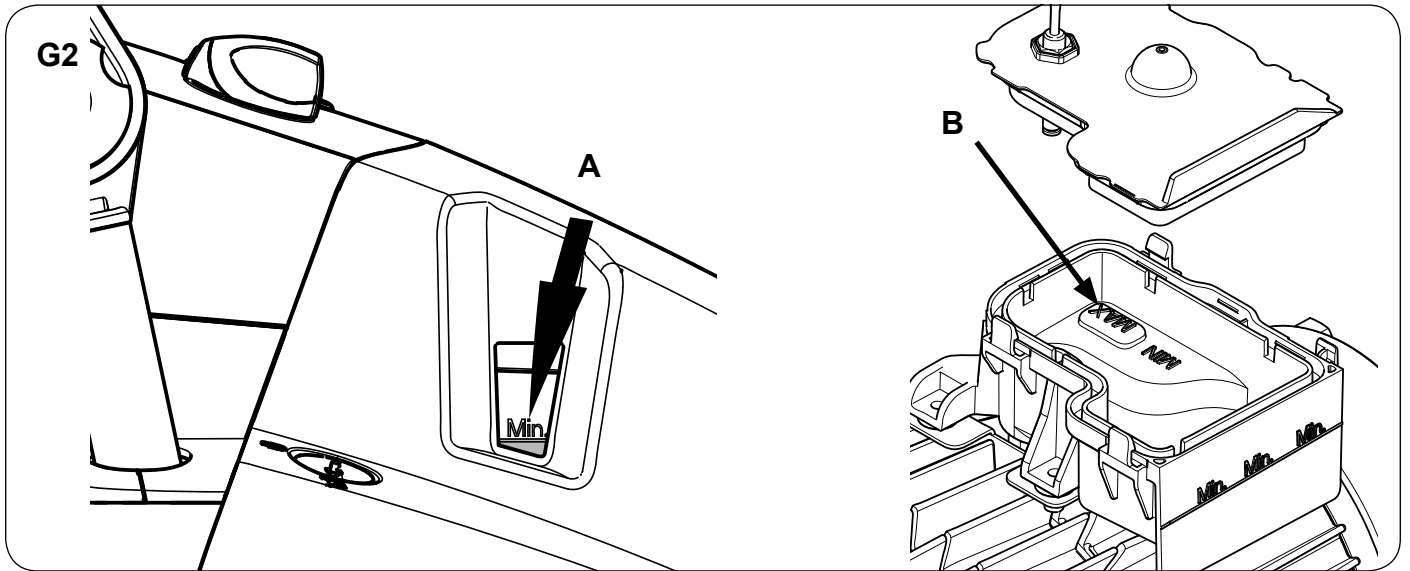

EN	Operating instructions	11
DE	Bedienungsanweisungen	15
FR	Instructions de fonctionnement	19
NL	Gebruiksaanwijzingen	23
IT	Istruzioni per l'uso	27
NO	Bruksanvisning	31
SV	Bruksanvisning	35
DA	Betjeningsvejledning	39
FI	Käyttöohje	43
ES	Instrucciones de funcionamiento	47
PT	Instruções de Funcionamento	51
EL	Οδηγίες λειτουργίας	55
TR	Kullanma Talimatları	59
SL	Navodila za delovanje	64
HR	Upute za uporabu	68
SK	Návod na obsluhu	72
CS	Návod k obsluze	76
PL	Instrukcje dotyczące obsługi	80
HU	Használati útmutató	84
RO	Instrucțiuni de utilizare.....	88
BG	Указания за експлоатация	92
RU	Руководство по эксплуатации	96
ET	Tööjuhised	100
LV	Norādījumi par ekspluatāciju	104
LT	Naudojimo instrukcija	108
ZH	操作说明.....	112
KO	사용법.....	116

Betjeningsvejledning

Denne højtryksrenser er designet til professionel brug, primært til følgende rengøringsopgaver:

Landbrug, industri, transportbranchen, rengøring af køretøjer, kommunale faciliteter, rengøringsbranchen, bygge- og anlægssektoren, fødevarerindustrien osv.

Lynguiden med illustrationer

Denne illustrerede guide har til formål at hjælpe dig med opstart, betjening og opbevaring af apparatet. Denne guide er inddelt i 8 afsnit.

A

LÆS SIKKERHEDSANVISNINGERNE FØR BRUG!

Betjeningslementer:

- A1. Kørehåndtag
- A2. Spulehåndtag¹⁾
- A3. Elkabel
- A4. Holder til højtryksslange
- A5. Højtryksslange
- A6. Befæstningsskrue
- A7. Dyserør¹⁾
- A8. Parkeringsbremse¹⁾
- A9. Højtryksslangeuds (på standardmodeller uden slangerulle)¹⁾
- A10. Vandtilslutning og vandtilgangsfilter
- A11. Oliesigtglas
- A12. Manometer¹⁾
- A13. Afbryderknop
- A14. Rengøringsmiddeldosering¹⁾
- A15. Vandmængderegulering¹⁾
- A16. Rengøringsmiddeltank¹⁾
- A17. Dæksellås

B

Før idriftsættelse

- B1. Inden den første ibrugtagning skal maskinen kontrolleres omhyggeligt for mangler og skader. I tilfælde af skader bedes De henvende Dem til Deres Nilfisk forhandler hurtigst muligt. Fold kørehåndtaget op, og lås det i driftsposition.

FORSIGTIG!

Løft aldrig maskinen alene. Bed altid en anden person om at hjælpe.

C

Klargøring af enheden:

- C1. Kontrollér olieniveauet. Lad renseren stå på en plan overflade, og kontrollér, at olieniveauet er over MIN-mærket (A), når olien er kold.
- C2. Påfyldning af rensmiddelbeholderen¹⁾:
 1. Fyld Nilfisk-rensmiddel på beholderen.
 2. Træk rengøringsmiddel-slange og filter frem, og stik dem ned i åbningen til rengøringsmiddeltanken.
- C3. Tilslutning af højtryksslange
 - a. Maskiner uden slangerulle: Højtryksslangen tilsluttes til højtryktilslutningen med hurtigkoblingen. OBS! Højtryksslangen må maksimalt have en længde på 50m.
 - b. Maskiner med slangerulle:
 1. Kobl højtryksslansens lynkobling (A) til studsens på akslen.
 2. Placér højtryksslangen i slangeføringen (B), og fiksér

den med klemmen¹⁾.

3. Løsn bremsen (C) på slangerullen¹⁾, og rul højtryksslangen op.
- C4. Tilslutning af vandslangen:
 1. Vandslangen skal kort skylles med vand før tilslutning til maskinen, så sand og snavs ikke kan komme ind i maskinen.
 2. Vandslangen tilsluttes til vandforsyningen med hurtigkoblingen.
 3. Vandhanen åbnes.

OBS! Hvis vandkvaliteten er ringe (sand osv.), anbefales det at montere et fintmasket filter på renseren. Filteret skal være på maks. 50 micron.

OBS! Vi anbefaler brug af en tekstil-armedet vandslange med en nominel diameter på min. Ø3/4" (19 mm).
- C5. BA-ventil: Denne højtryks-vasker/-renser må kun tilsluttes drikke-vandforsyningen, hvis der er monteret en korrekt tilbagestrømningsspærre af type BA i henhold til EN 60335-2-79.

BA-ventilen bestilles under nummer: (C: BA-ventil):

- BA-ventil med GARDENA-koblinger: 106411177
- BA-ventil med NITO-koblinger: 106411178
- BA-ventil med GEKA-koblinger: 106411179
- BA-ventil uden koblinger: 106411184

Koblingerne kan bestilles under nummer: (A: Hunkobling, B: Hankobling):

- 3/4" GARDENA (A): 1608629
- 3/4" GARDENA (B): 32541
- 3/4" NITO (A): 1602945
- 3/4" NITO (B): 1600659
- 1/2" NITO (B): 1604669
- 3/4" GEKA (A): 1718
- 3/4" GEKA (B): 1311

Installationsvejledning:

1. Montér en hankobling på vandhanen.
2. Tilslut (A) på BA-ventilen til vandhanen.
3. Montér en hunkobling på vandindløbsslangen.
4. Tilslut (B) på BA-ventilen til vandindløbsslangen.
5. Tilslut vandindløbsslangen til højtryksvaskeren.
6. Åbn for vandet og start maskinen.

GIV AGT!

- Tilbagestrømningssikringen kan monteres enten lodret eller vandret, og afløbsåbningen (D) skal monteres, så den peger nedad.
- Vandstrømmen fra afløbsåbningen (D) skal kunne strømme frit.
- Hvis der er risiko for, at der kan løbe sand ind i det indløbende vand (f.eks. fra din egen brønd) bør der monteres et ekstra filter mellem vandhanen og tilbagestrømningssikringen.
- Længden på slangen mellem tilbagestrømningsspærren og højtryksvaskeren skal være mindst 12 meter (min. diameter 3/4 tomme) til dæmpning af evt. trykspidser.
- Så snart vandet er strømmet igennem BA-ventilen, anses det ikke længere for at være drikkevand.
- Beskyt tilbagestrømningssikringen mod at blive udsat for frost.
- Hold tilbagestrømningssikringen ren og fri for snavs.

¹⁾ Specialtilbehør / modelvarianter

Vedligeholdelse

Kontrollér funktionen mindst én gang om året på følgende måde:

1. Sluk for højtryksrensere efter afsluttet arbejde.
2. Luk vandhanens ventil.
3. Udløs trykket i vandforsyningsslangen ved at løsne spulehåndtagets spærre.
4. Afmonter tilbagestrømningssikringen. Vandet skal løbe ud af afløbsåbningen (D) (maks. 100ml) for at sikre, at det adskilles fra drikkevandet.
5. Hvis det ikke er tilfældet, skal du forsøge at rengøre BA-ventilen eller kontakte din Nilfisk-repræsentant.

C6. Tilslutning til elnettet

1. Følg sikkerhedsanvisningerne
2. Sæt stikket i stikkontakten.

FORSIGTIG!

- Før tilslutning af maskiner med spændingsomskiftning: Kontrollér, at den forvalgte spænding på renseren stemmer overens med elnettets spænding. I modsat fald kan renserens elektriske dele blive ødelagt¹⁾.

- Ved brug af kabeloprul: Rul kablet helt ud.

- Højtryksrensere skal altid tilsluttes en korrekt installeret stikkontakt.

C7. Frigørelse af kablet

1. Drej kabelkrogen (A).
2. Frigør kablet (B).
3. Drej kabelkrogen tilbage.

D

Start af enheden

D1. Tilslutning af lanse til spulehåndtag.

1. Træk det blå greb på lynkoblingen (A) på spulehåndtaget tilbage.
2. Placér dyserørets studs (B) i lynkoblingen (A), og slip det blå greb.
3. Lansen (eller andet tilbehør) trækkes frem for at sikre, at det er fast forbundet med spulehåndtaget. OBS! Nippelen skal altid renses for eventuelt snavs, før lansen forbindes med spulehåndtaget. OBS! Den omgivende temperatur skal være over 0 °C og ikke højere end 40 °C. Maskintemperaturen må ikke være under 0 °C.

D2.a Sådan startes renseren, ved tilslutning til en vandledning:

1. Hovedafbryderen sættes i position "I".
2. Spulehåndtagets sikkerhedspal løsnes og pistolen betjenes.
3. Sikkerhedspalen låses, også ved korte arbejdsafbrydelser.

OBS! Aktivér spulehåndtaget nogle gange hurtigt efter hinanden for at lufte systemet ud. Renseren slukker automatisk, når spulehåndtaget slippes. Renseren starter igen, når spulehåndtaget aktiveres. DSS-modeller slukker med en forsinkelse på 20 sekunder¹⁾.

D2.b Sådan startes renseren, når den er tilsluttet en åben tank under sugedrift¹⁾ (trykaktiveret model):

1. Før tilslutning af sugedrift-udstyr: 61256 til renseren, skal slangen fyldes med vand.
2. Drej afbryderknappen til position "I".
3. Lås spulehåndtaget op, og aktivér det.

D2.c Sådan startes renseren, når den er tilsluttet en åben tank under sugedrift¹⁾ (flowaktiveret model)

1. Før tilslutning af sugedriftudstyr: 61256 til renseren, skal slangen fyldes med vand.
2. Drej afbryderknappen til position "M".

3. Lås spulehåndtaget op, og aktivér det.

4. Renseren starter igen, når spulehåndtaget aktiveres.

OBS! Renseren stopper automatisk efter en pause på mere end fem minutter. Se specification for maks. sugehøjde.

D3. Trykregulering med Tornado Plusdyserøret og PowerSpeedVario Plus-dyserøret.:

Højtryk = med uret (+)

Lavtryk = mod uret (-)

D4. Trykregulering med FlexoPowerPlus-dyserøret og PowerSpeedVario Plus-dyserøret. Drej den yderste hætte på FlexoPowerPlus-dyserøret:

Højt tryk = MAX.

Lavt tryk = MIN. (CHEM)

D5. Brug af rengøringsmidler: Rengøringsmidler kan kun suges ind gennem standard injektoren ved drift med lavt tryk:

1. Bland rengøringsmiddel i henhold til producentens vejledning om blandingsforhold.

2. Tornado Plus-dyserøret og PowerSpeedVario Plus-dyserøret¹⁾: Indstil trykreguleringen på dyserøret til lavtryk (-), eller på FlexoPowerPlus-dyserøret¹⁾:

Drej den yderste hætte på FlexoPowerPlus-dyserøret hele vejen over på "CHEM".

3. Mængden af rengøringsmiddel reguleres ved at dreje doseringsventilen.

4. Vælg tank A ved at dreje doseringsventilen til "A". Vælg tank B ved at dreje doseringsventilen til "B"

5. Afbryderknap: Drej afbryderknappen til "I".

6. Aktivér spulehåndtaget.

OBS! Rengøringsmidler må ikke tørre ind! Overfladen, som skal renses, kan blive beskadiget!

E

Løft med kran

- E1. Før løft med kran skal der være ligevægt i renseren. Løsn skruen (A), og skub håndtaget (B) let fremad.
- E2. Når de to mærker står over for hinanden (C), er håndtaget i kranløftposition.
- E3. Sørg for at spænde skruen (D) i løftposition. Placér løftestroppen rundt om håndtaget (E) midtpå, så kranen kan gribe fat i den. ADVARSEL! Stå aldrig under en maskine, der hænger i luften.

F

Efter brug af enheden eller før du forlader den uden opsyn

F1. Sluk for højtryksrensere:

1. Sluk for hovedafbryderen, omskifter i position "OFF".
2. Luk for vandhanen.
3. Spulehåndtaget betjenes, indtil maskinen ikke længere er under tryk.
4. Lås sikkerhedspalen på spulehåndtaget.
5. Vandslangen løsnes fra maskinen.
6. Maskinens stik trækkes ud af stikkontakten.

F2. Oprulning af slange og opbevaring af dyserør. For at undgå ulykker er det vigtigt altid at rulle slangen op.

1. Rul slangen op som vist.
2. Placér dyserøret i dyserørs-holderen.

F3. Oprulning af kablet

1. Rul kablet op forfra over fæsteskrue (A) og med uret rundt om kabelkroge (B).
2. Drej og lås til sidst enden af kablet fast i kabellåsen (C).

G

Service

- G1. Rensning af vandfilter. Ved vandtilløbet er der monteret et vandfilter, som skal forhindre grove snavspartikler i at trænge ind i pumpen.
1. Skru hurtigkoblingen af.
 2. Tag filteret ud og skyl det. Et beskadiget filter udskiftes.
- G2. Kontrol af olieniveau
1. Kontrollér olieniveauet. Lad renseren stå på et plant underlag, og kontrollér, at olieniveauet er over MIN-mærket (A), når olien er kold.
 2. Påfyld om nødvendigt olie. Fyld op til MAX-mærket (B).
- G3. Olieskift
1. Før olieskift skal renseren være varm.
 2. Afmonter kabinettet.
 3. Løsn og fjern aftapnings-proppen (C). Magneten på proppen skal renses med en klud eller et stykke papir for at fjerne alle metalpartikler. Tøm olien ud i en egnet beholder (min. 1 liter), og bortskaf olien i henhold til de lokale bestemmelser.
 4. Montér aftapningsproppen igen, og fyld olie på som anført i afsnit specification.
 5. Olieniveauet skal være over MIN-mærket i olietanken, når renseren står på et plant underlag. Fyld op til MAX-mærket (B).
 6. Montér kabinettet igen.
- G4. Kontroller pumpeoliens kvalitet: Kontroller pumpeoliens farve. Hvis olien har en hvid tone, skal Nilfisk Service kontaktes! Fyld den kolde pumpe med frisk olie til MAX-mærket, hvis det er nødvendigt.
- OBS! Brug en speciel pumpeolie, hvis renseren anvendes i områder med fødevarer. Kontakt nærmeste Nilfisk forhandler for vejledning.

Serviceplan

	ugentlig	efter hver 500 driftstimer	efter behov
Rensning af vandfilter			●
Lynkoblingssmørenipler til slange, spulehåndtag og dyserør	●		
Kontrol af olieniveau	●		
Skift pumpeolien		●	
Kontroller pumpeoliens kvalitet	●		

H

Opbevaring af maskinen (frostsikker lagring)

Maskinen opbevares i et tørt, frostsikkert lokale, som beskrevet nedenfor:

Når højtryksrenseren opbevares i et lokale, hvor temperaturen kan ligge omkring 0°C eller derunder, skal der forinden suges frostbeskyttelse ind gennem pumpen:

1. Vandforsyningsslangen fjernes.
2. Dyserørets tages af.
3. Maskinen tændes, Drej afbryderknappen til position "I". Sluk maskinen efter max. 3 minutter.
4. Indsugningsslangen sættes til maskinens vandindløb og placeres i en beholder med frostbeskyttelse.
5. Maskinen tændes, drej afbryderknappen til position "I".
6. Spulehåndtaget holdes over beholderen med frostbeskyttelse og betjenes for at starte indsugningen.

7. Under indsugningen betjenes spulehåndtaget 2-3 gange.
8. Indsugningsslangen løftes ud af beholderen med frostbeskyttelse og spulehåndtaget betjenes for at pumpe det resterende frostbeskyttelsesmiddel ud.
9. Maskinen slukkes.
10. For at undgå enhver risiko skal maskinen inden næste ibrugtagning midlertidigt anbringes i et varmt lokale.

Andet

Bortskafning af maskinen:

Det udtjente apparat skal gøres ubrugelig med det samme. Tag netstikket ud og klip ledningen over.

Elektriske apparater må ikke bortskaffes sammen med almindeligt husholdningsaffald!

Garanti:

Med hensyn til garanti gælder vore generelle salgs- og leveringsbetingelser. Ændringer i medfør af tekniske videreudviklinger forbeholdes.

Afhjælpning af fejl

Fejl	Årsag	Afhjælpning
Trykfald	<ul style="list-style-type: none"> Luft i systemet Højtryks-dyse tilstoppet / slidt Rensemiddelbeholder tom 	<ul style="list-style-type: none"> Systemet ventileres, betjen hertil spulehåndtaget flere gange med korte mellemrum, eventuelt tages maskinen kortvarigt i drift uden tilsluttet højtrykslange. Rens/skift højtryks-dysen. Fyld rengørings-middeltanken op, eller indstil doseringen til "0".
Svingende tryk	<ul style="list-style-type: none"> Pumpe indsuger luft (kun muligt i suge modus) Vandmangel Vandforsyningssslange for lang hhv. for ringe diameter Vandmangel på grund af tilstoppet vandfilter Vandmangel pga. manglende overholdelse af den maksimalt tilladte ind sugningshøjde 	<ul style="list-style-type: none"> Kontroller sugesættets lufttæthed. Åbn for vandhanen. Benyt en vandtil-gangsslange, der giver den vandmængde (Q_{max}), rensen er specificeret til. Vandfilteret i vandtil-slutningen renses (arbejd aldrig uden vandfilter!). Se idriftsættelse
Motoren starter ikke op, når maskinen tændes	<ul style="list-style-type: none"> Stikket er ikke sat rigtigt i stikkontakten, strømsvigt Oliestand for lav El-nettets sikring er slået fra Overlastsikringen har reageret, fordi motoren er blevet for varm eller den er overbelastet. 	<ul style="list-style-type: none"> Kontrollér stik, kabel og kontakt, og lad om nødvendigt en autoriseret elektriker udskifte dem. Kontrollér oliestand/påfyld olie Slå sikringen til Sørg for, at forsynings-spændingen svarer til maskinens spænding. Sluk for maskinen og lad den køle af i mindst 3 minutter.
Motoren brummer og starter ikke op, når den tændes	<ul style="list-style-type: none"> El-forsynings-spændingen er for lav eller en fase har svigtet. Pumpen er blokeret eller frosset fast. Forlængerledningen har forkert ledningstværsnit eller længde. 	<ul style="list-style-type: none"> Få el-forsyningen kontrolleret. Tilkald Nilfisk kundeservice. Benyt ledning med det rigtige tværsnit og den rigtige længde.
Motoren slukker	<ul style="list-style-type: none"> Overlastsikringen har reageret, fordi motoren er blevet for varm eller den er overbelastet. Højtryksdysen er snavset. 	<ul style="list-style-type: none"> Sørg for, at forsynings-spændingen svarer til maskinens spænding. Sluk for maskinen og lad den køle af i mindst 3 minutter. Skift højtryksdysen.
Suger ikke rengøringsmiddel	<ul style="list-style-type: none"> Rengøringsmiddeltanken er tom Hætten på FlexoPower-Plus-dyserøret er ikke indstillet til lavtryk Dobbelt dyserøret er ikke indstillet til lavtryk. Injektoren er snavset, eller sugeslangen er blokeret. 	<ul style="list-style-type: none"> Fyld rengøringsmiddel i tanken Indstil dyserøret til lavtryk Indstil dyserøret til lavtryk Rens

Declaration of Conformity

Prohlášení o shodě
 Konformitätserklärung
 Overensstemmelseserklæring
 Declaración de conformidad
 Vastavusdeklaratsioon
 Déclaration de conformité
 Vaatimustenmukaisuusvakuutus

Декларация за съответствие
 Δήλωση συμμόρφωσης
 Megfelelősségi nyilatkozat
 Izjava o skladnosti
 Dichiarazione di conformità
 Atitikties deklaracija
 Atbilstības deklarācija
 Samsvarserklæring
 Conformiteitsverklaring

Declaração de conformidade
 Deklaracja zgodności
 Declaratie de conformitate
 Декларация о соответствии
 Försäkran om överensstämmelse
 Vyhlášení o zhode
 Izjava o skladnosti
 Uygunluk beyanı

Manufacturer / Výrobce / Hersteller / Fabrikant /
 Fabricante / Κατασκευαστής / Gyártó / Proizvođač /
 Fabbicante / Gamintojas / Ražotājs / Producent /
 Fabrikant / Fabricante / Producent / Producător /
 производитель / Tillverkaren / Výrobca / Proizvajalec /
 Üretici firma:

**Nilfisk A/S, Kornmarksvej 1
 DK-2605 Broendby, DENMARK**

Product / Produkt / Producto, Toode, Produit, Tuote /
 Продукт / Προϊόν / Termék / Proizvod / Prodotto /
 Produktas / Produkts / Artikel / Produtos / Prods /
 Izdelek / Ürün

MC 5M, -6P, -7P

Description / Popis / Beschreibung / Beskrivelse /
 Descripción / Kirjeldus / La description / Kuvaus /
 Описание / Περιγραφή / Leirás / Opis / Descrizione /
 Aprašymas / Apraksts / Beschrijving / Descrição /
 Descriere / Beskrivning / Popis / Açıklama

**HPW - Professional - Mobile - EI
 230V 1~, 230/400V, 400V 3~, 50Hz, IPX5**

EN

**We, Nilfisk hereby declare under our sole
 responsibility, that the above-mentioned
 product(s) is/are in conformity with the
 following directives and standards.**

LT

Mes, „Nilfisk“, prisiimdami visišką
 atsakomybę pareiškiame, kad pirmiau
 minėtas produktas (-ai) atitinka šias
 direktyvas ir standartus

CS

My, Nilfisk prohlašujeme na svou výlučnou
 odpovědnost, že výše uvedený výrobek je ve
 shodě s následujícími směrnici a normami.

LV

Mēs, Nilfisk, ar pilnu atbildību apliecinām, ka
 iepriekšminētais produkts atbilst šādām
 direktīvām un standartiem

DE

Wir, Nilfisk erklären in alleiniger
 Verantwortung, dass das oben genannte
 Produkt den folgenden Richtlinien und
 Normen entspricht.

NO

Vi, Nilfisk erklærer herved under eget ansvar,
 at det ovennevnte produktet er i samsvar
 med følgende direktiver og standarder

DA

Vi, Nilfisk erklærer hermed under eget ansvar
 at ovennævnte produkt(er) er i
 overensstemmelse med følgende direktiver og
 standarder.

NL

We verklaren Nilfisk hierbij op eigen
 verantwoordelijkheid, dat het
 bovengenoemde product voldoet aan de
 volgende richtlijnen en normen

ES

Nosotros, Nilfisk declaramos bajo nuestra
 única responsabilidad que el producto antes
 mencionado está en conformidad con las
 siguientes directivas y normas

PT

Nós, a Nilfisk declaramos, sob nossa exclusiva
 responsabilidade, que o produto acima
 mencionado está em conformidade com as
 diretrizes e normas a seguir

ET

Meie, Nilfisk Käesolevaga kinnitame ja
 kanname ainuisikulist vastutust, et eespool
 nimetatud toode on kooskõlas järgmiste
 direktiivide ja

PL

My, Nilfisk Niniejszym oświadczamy z pełną
 odpowiedzialnością, że wyżej wymieniony
 produkt jest zgodny z następującymi
 dyrektywami i normami..



Nilfisk déclare sous notre seule responsabilité que le produit mentionné ci-dessus est conforme aux directives et normes suivantes.



Me, Nilfisk täten vakuutamme omalla vastuulla, että edellä mainittu tuote on yhdenmukainen seuraavien direktiivien ja standardien mukaisesti



Ние, Nilfisk С настоящото декларираме на своя лична отговорност, че посочените по-горе продуктът е в съответствие със следните директиви и стандарти.



Εμείς, Nilfisk δηλώνουμε με αποκλειστική μας ευθύνη, ότι το προαναφερόμενο προϊόν συμμορφώνεται με τις ακόλουθες οδηγίες και πρότυπα.



Mi, Nilfisk Kijelentjük, egyedüli felelősséggel, hogy a fent említett termék megfelel az alábbi irányelveknek és szabványoknak



Mi, Nilfisk Izjavljujemo pod punom odgovornošću, da gore navedeni proizvod u skladu sa sljedećim direktivama i standardima.



Noi, Nilfisk dichiara sotto la propria responsabilità, che il prodotto di cui sopra è conforme alle seguenti direttive e norme.



Noi, Nilfisk Prin prezenta declarăm pe propria răspundere, că produsul mai sus menționat este în conformitate cu următoarele standarde și directive



Мы, Nilfisk настоящим заявляем под нашу полную ответственность, что вышеперечисленные продукция соответствует следующими директивам и стандартам.



Vi Nilfisk förklarar härmed under eget ansvar att ovan nämnda produkt överensstämmer med följande direktiv och normer.



My, Nilfisk prehlasujeme na svoju výlučnú zodpovednosť, že vyššie uvedený výrobok je v zhode s nasledujúcimi smernicami a normami.



Mi, Nilfisk izjavljamo s polno odgovornostjo, da je zgoraj omenjeni izdelek v skladu z naslednjimi smernicami in standardi.



Nilfisk, burada yer alan tüm sorumluluklarımıza göre, yukarıda belirtilen ürünün aşağıdaki direktifler ve standartlara uygun olduğunu beyan ederiz.















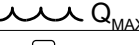

2006/42/EC	EN 60335-1:2012+A11:2014+A13:2017 EN 60335-2-79:2012
2014/30/EU	EN 55014-1:2017+A11:2020 EN 55014-2:2015 EN 61000-3-2:2014 EN 61000-3-11:2000
2011/65/EU	EN 63000:2018
2000/14/EC – Conformity assessment procedure according to Annex V.	- Measured sound power level: 82-93 dB(A); Guaranteed sound power level: 85-96 dB(A)

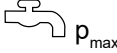
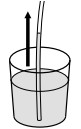
Authorized signatory:













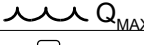
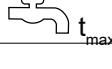
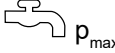
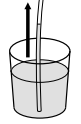

Pierre Mikaelsson, Executive Vice President, Global Products & Services, Nilfisk NLT

Oct 14, 2020













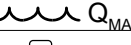
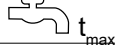
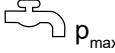
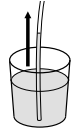

Specifications

			5M-180/840	5M-180/840 XT	5M-200/1000	5M-200/1000 XT
1			EU	EU	EU	EU
2		V/ph/Hz	400/3/50	400/3/50	400/3/50	400/3/50
3		A	16	16	16	16
4		kW кВт	4,8	4,8	6,1	6,1
5		bar (MPa) Бар (МПа) 巴 (兆帕)	180 (18)	180 (18)	200 (20)	200 (20)
6		l/h л/час 升/小时	760	760	940	940
7		bar (MPa) Бар (МПа) 巴 (兆帕)	250 (25)	250 (25)	250 (25)	250 (25)
8		l/h	840	840	1000	1000
9		°C (°F)	60 (140)	60 (140)	60 (140)	60 (140)
10		bar (MPa) Бар (МПа) 巴 (兆帕)	10 (1)	10 (1)	10 (1)	10 (1)
11		m 米	1	1	1	1
12		mm 毫米	735x570x1020	890x570x1020	735x570x1020	890x570x1020
13		kg кг	66	72	71	76
14	 $K_{PA} = 3 \text{ dB}$	dB(A) дБ(A)	75	75	76	76
15	 $K_{WA} = 3 \text{ dB}$	dB(A) дБ(A)	88	88	89	89
16	 (ISO 5349 a_h)	m/s ² 米/秒 ²	≤ 2,5	≤ 2,5	≤ 2,5	≤ 2,5
17		N	34,4	34,9	44,7	45,4
18		l 升	0,73	0,73	0,73	0,73
19			Castrol Alphasyn 150	Castrol Alphasyn 150	Castrol Alphasyn 150	Castrol Alphasyn 150













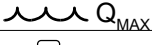
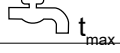
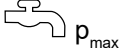
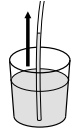

Specifications

			5M-200/1050 FA	5M-200/1050	5M-200/1050 XT	5M-220/1130 FA
1			EU	EU	EU	EU
2		V/ph/Hz	400/3/50	400/3/50	400/3/50	400/3/50
3		A	16	16	16	16
4		kW кВт	6,1	6,1	6,1	7,4
5		bar (MPa) Бар (МПа) 巴 (兆帕)	200 (20)	200 (20)	200 (20)	220 (22)
6		l/h л/час 升/小时	960	960	960	1040
7		bar (MPa) Бар (МПа) 巴 (兆帕)	250 (25)	250 (25)	250 (25)	250 (25)
8		l/h	1050	1050	1050	1130
9		°C (°F)	60 (140)	60 (140)	60 (140)	60 (140)
10		bar (MPa) Бар (МПа) 巴 (兆帕)	10 (1)	10 (1)	10 (1)	10 (1)
11		m 米	1	1	1	1
12		mm 毫米	735x570x1020	735x570x1020	890x570x1020	735x570x1020
13		kg кг	73	73	78	79
14	 $K_{PA} = 3 \text{ dB}$	dB(A) дБ(A)	76	76	76	75
15	 $K_{WA} = 3 \text{ dB}$	dB(A) дБ(A)	89	89	89	88
16	 (ISO 5349 a_h)	m/s ² 米/秒 ²	≤ 2,5	≤ 2,5	≤ 2,5	≤ 2,5
17		N	46	46	46,5	52,8
18		l 升	0,73	0,73	0,73	0,73
19			Castrol Alphasyn 150	Castrol Alphasyn 150	Castrol Alphasyn 150	Castrol Alphasyn 150













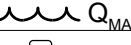
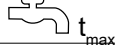
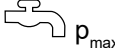
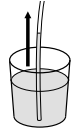

Specifications

			5M-220/1130	5M-220/1130 XT	5M-200/1050	5M-200/1050 XT
1			EU	EU	NO,BE	NO,BE
2		V/ph/Hz	400/3/50	400/3/50	230-400/ 3/50	230-400/ 3/50
3		A	16	16	25	25
4		kW кВт	7,4	7,4	6,1	6,1
5		bar (MPa) Бар (МПа) 巴 (兆帕)	220 (22)	220 (22)	200 (20)	200 (20)
6		l/h л/час 升/小时	1040	1040	960	960
7		bar (MPa) Бар (МПа) 巴 (兆帕)	250 (25)	250 (25)	250 (25)	250 (25)
8		l/h	1130	1130	1050	1050
9		°C (°F)	60 (140)	60 (140)	60 (140)	60 (140)
10		bar (MPa) Бар (МПа) 巴 (兆帕)	10 (1)	10 (1)	10 (1)	10 (1)
11		m 米	1	1	1	1
12		mm 毫米	735x570x1020	890x570x1020	735x570x1020	890x570x1020
13		kg кг	78	85	75	80
14	 $K_{PA} = 3 \text{ dB}$	dB(A) дБ(A)	75	75	76	76
15	 $K_{WA} = 3 \text{ dB}$	dB(A) дБ(A)	88	88	89	89
16	 (ISO 5349 a_h)	m/s ² 米/秒 ²	≤ 2,5	≤ 2,5	≤ 2,5	≤ 2,5
17		N	52,8	54	46	46,5
18		l 升	0,73	0,73	0,73	0,73
19			Castrol Alphasyn 150	Castrol Alphasyn 150	Castrol Alphasyn 150	Castrol Alphasyn 150













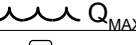
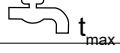
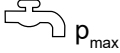
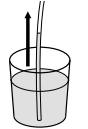

Specifications

			5M-100/770	5M-100/770 XT	5M-200/1050	5M-220/1130
1			UK	UK	EXP	EXP
2		V/ph/Hz	230/1/50	230/1/50	220-440/ 3/60	220-440/ 3/60
3		A	13	13	20	30
4		kW кВт	2,9	2,9	6,1	7
5		bar (MPa) Бар (МПа) 巴 (兆帕)	100 (10)	100 (10)	200 (20)	220 (22)
6		l/h л/час 升/小时	700	700	960	1040
7		bar (MPa) Бар (МПа) 巴 (兆帕)	150 (15)	150 (15)	250 (25)	250 (25)
8		l/h	770	770	1050	1130
9		°C (°F)	60 (140)	60 (140)	60 (140)	60 (140)
10		bar (MPa) Бар (МПа) 巴 (兆帕)	10 (1)	10 (1)	10 (1)	10 (1)
11		m 米	1	1	1	1
12		mm 毫米	735x570x1020	890x570x1020	735x570x1020	735x570x1020
13		kg кг	68	73	74	80
14	 $K_{PA} = 3 \text{ dB}$	dB(A) дБ(A)	68	68	76	75
15	 $K_{WA} = 3 \text{ dB}$	dB(A) дБ(A)	82	82	89	88
16	 (ISO 5349 a_h)	m/s ² 米/秒 ²	≤ 2,5	≤ 2,5	≤ 2,5	≤ 2,5
17		N	23,5	23,7	45,6	52,8
18		l 升	0,73	0,73	0,73	0,73
19			Castrol Alphasyn 150	Castrol Alphasyn 150	Castrol Alphasyn 150	Castrol Alphasyn 150



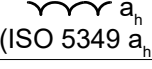









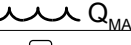
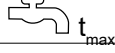
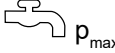
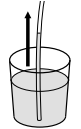

Specifications

			5M-115/700	5M-200/1030	6P-250/1100 FA	6P-250/1100 FA
1			AU	AU	EU	EXP
2		V/ph/Hz	240/1/50	415/3/50	400/3/50	220-440/ 3/60
3		A	15	20	16	30
4		kW кВт	3	6,1	8,5	8,5
5		bar (MPa) Бар (МПа) 巴 (兆帕)	115(11,5)	200(20)	250 (25)	250 (25)
6		l/h л/час 升/小时	630	950	1000	1000
7		bar (MPa) Бар (МПа) 巴 (兆帕)	172,5(17,25)	250(25)	250 (25)	250 (25)
8		l/h	700	1030	1100	1100
9		°C (°F)	60(140)	60(140)	80 (176)	80 (176)
10		bar (MPa) Бар (МПа) 巴 (兆帕)	10 (1)	10 (1)	10 (1)	10 (1)
11		m 米	1	1	1	1
12		mm 毫米	735x570x1020	735x570x1020	775x570x1020	775x570x1020
13		kg кг	68	73	89	89
14	 $K_{PA} = 3 \text{ dB}$	dB(A) дБ(A)	68	76	80	80
15	 $K_{WA} = 3 \text{ dB}$	dB(A) дБ(A)	82	89	93	93
16	 (ISO 5349 a_h)	m/s ² 米/秒 ²	≤ 2,5	≤ 2,5	≤ 2,5	≤ 2,5
17		N	22,8	46,4	54,1	57,2
18		l 升	0,73	0,73	0,95	0,95
19			Castrol Alphasyn T 150	Castrol Alphasyn T 150	Castrol Alphasyn 150	Castrol Alphasyn 150



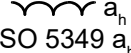











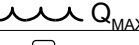

Specifications

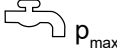
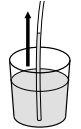
			6P-180/1300 FA	6P-180/1300 FA	6P-170/1600 FA	6P-250/1100 FAXT
1			EU	EXP	EU	EU
2		V/ph/Hz	400/3/50	220-440/ 3/60	400/3/50	400/3/50
3		A	16	30	16	16
4		kW кВт	7,4	8,2	8,8	8,8
5		bar (MPa) Бар (МПа) 巴 (兆帕)	180 (18)	180 (18)	170 (17)	250 (25)
6		l/h л/час 升/小时	1200	1200	1500	1000
7		bar (MPa) Бар (МПа) 巴 (兆帕)	250 (25)	250 (25)	250 (25)	250 (25)
8		l/h	1300	1300	1600	1100
9		°C (°F)	80 (176)	80 (176)	80 (176)	80 (176)
10		bar (MPa) Бар (МПа) 巴 (兆帕)	10 (1)	10 (1)	10 (1)	10 (1)
11		m 米	1	1	1	1
12		mm 毫米	775x570x1020	775x570x1020	775x570x1020	930x570x1020
13		kg кг	86	87	89	96
14	 $K_{PA} = 3 \text{ dB}$	dB(A) дБ(A)	77	77	77	80
15	 $K_{WA} = 3 \text{ dB}$	dB(A) дБ(A)	90	90	90	93
16	 (ISO 5349 a_h)	m/s ² 米/秒 ²	≤ 2,5	≤ 2,5	≤ 2,5	≤ 2,5
17		N	56,4	58	68,2	54,6
18		l 升	0,95	0,95	0,95	0,95
19			Castrol Alphasyn 150	Castrol Alphasyn 150	Castrol Alphasyn 150	Castrol Alphasyn 150













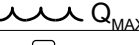
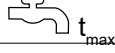
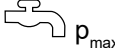
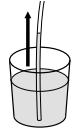

Specifications

			6P-180/1300 FAXT	6P-180/1300 FAXT	6P-170/1600 FAXT	6P-200/1100 FAXT
1			EU	NO, BE	EU	EU
2		V/ph/Hz	400/3/50	230-400/3/50	400/3/50	400/3/50
3		A	16	25	16	16
4		kW кВт	7,7	7,7	9	7,3
5		bar (MPa) Бар (МПа) 巴 (兆帕)	180 (18)	180 (18)	170 (17)	200 (20)
6		l/h л/час 升/小时	1200	1200	1500	1000
7		bar (MPa) Бар (МПа) 巴 (兆帕)	250 (25)	250 (25)	250 (25)	250 (25)
8		l/h	1300	1300	1600	1100
9		°C (°F)	80 (176)	80 (176)	80 (176)	80 (176)
10		bar (MPa) Бар (МПа) 巴 (兆帕)	10 (1)	10 (1)	10 (1)	10 (1)
11		m 米	1	1	1	1
12		mm 毫米	930x570x1020	930x570x1020	930x570x1020	930x570x1020
13		kg кг	93	93	96	85
14	 $K_{PA} = 3 \text{ dB}$	dB(A) дБ(A)	77	77	77	75
15	 $K_{WA} = 3 \text{ dB}$	dB(A) дБ(A)	90	90	90	88
16	 (ISO 5349 a_h)	m/s ² 米/秒 ²	≤ 2,5	≤ 2,5	≤ 2,5	≤ 2,5
17		N	57,4	57,4	68,9	52,2
18		l 升	0,95	0,95	0,95	0,95
19			Castrol Alphasyn 150	Castrol Alphasyn 150	Castrol Alphasyn 150	Castrol Alphasyn 150



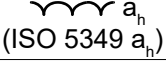









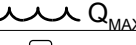
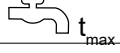
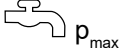
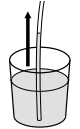

Specifications

		6P-250/1100 FA	6P-120/1950 FA	6P-120/1950 FAXT	6P-120/1950 FA	
1		AU	EU	EU	NO	
2		V/ph/Hz	415/3/50	400/3/50	400/3/50	230-400/3/50
3		A	20	16	16	32
4		kW кВт	8,5	8,8	8,8	8,8
5		bar (MPa) Бар (МПа) 巴 (兆帕)	250 (25)	120 (12)	120 (12)	120 (12)
6		l/h л/час 升/小时	1000	1850	1850	1850
7		bar (MPa) Бар (МПа) 巴 (兆帕)	250 (25)	175 (17,5)	175 (17,5)	175 (17,5)
8		l/h	1100	1950	1950	1950
9		°C (°F)	80 (176)	80 (176)	80 (176)	80 (176)
10		bar (MPa) Бар (МПа) 巴 (兆帕)	10 (1)	10 (1)	10 (1)	10 (1)
11		m 米	1	1	1	1
12		mm 毫米	775x570x1020	775x570x1020	775x570x1020	775x570x1020
13		kg кг	89	89	96	89
14	 $K_{PA} = 3 \text{ dB}$	dB(A) дБ(A)	80	77	77	77
15	 $K_{WA} = 3 \text{ dB}$	dB(A) дБ(A)	93	90	90	90
16	 (ISO 5349 a_h)	m/s ² 米/秒 ²	≤ 2,5	≤ 2,5	≤ 2,5	≤ 2,5
17		N	54,1	75,9	77,6	75,9
18		l 升	0,95	0,95	0,95	0,95
19			Castrol Alphasyn T 150	Castrol Alphasyn T 150	Castrol Alphasyn T 150	Castrol Alphasyn T 150



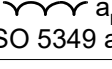

Specifications

			7P-195/1280 FA	7P-195/1280 FAXT	7P-195/1280 FA	7P-195/1280 FA
1			EU,DK	EU	NO, BE	EXP
2		V/ph/Hz	400/3/50	400/3/50	230-400/3/50	220-440/3/60
3		A	16	16	25	30
4		kW кВт	8	8	8	8
5		bar (MPa) Бар (МПа) 巴 (兆帕)	195 (19,5)	195 (19,5)	195 (19,5)	195 (19,5)
6		l/h л/час 升/小时	1180	1180	1180	1180
7		bar (MPa) Бар (МПа) 巴 (兆帕)	250 (25)	250 (25)	250 (25)	250 (25)
8		l/h	1280	1280	1280	1280
9		°C (°F)	85 (185)	85 (185)	85 (185)	85 (185)
10		bar (MPa) Бар (МПа) 巴 (兆帕)	10 (1)	10 (1)	10 (1)	10 (1)
11		m 米	1	1	1	1
12		mm 毫米	775x570x1020	930x570x1020	775x570x1020	775x570x1020
13		kg кг	89	95	90	93
14	 $K_{PA} = 3 \text{ dB}$	dB(A) дБ(A)	75	75	76	75
15	 $K_{WA} = 3 \text{ dB}$	dB(A) дБ(A)	88	88	89	88
16	 (ISO 5349 a_h)	m/s ² 米/秒 ²	≤ 2,5	≤ 2,5	≤ 2,5	≤ 2,5
17		N	57,8	58,6	57,8	60
18		l 升	1,1	1,1	1,1	1,1
19			Castrol Alphasyn 150	Castrol Alphasyn 150	Castrol Alphasyn 150	Castrol Alphasyn 150





Specifications

			7P-195/1280 FA
1			AU
2		V/ph/Hz	415/3/50
3		A	20
4		kW кВт	8
5		bar (MPa) Бар (МПа) 巴 (兆帕)	195(19,5)
6		l/h л/час 升/小时	1180
7		bar (MPa) Бар (МПа) 巴 (兆帕)	250(25)
8		l/h	1280
9		°C (°F)	85(185)
10		bar (MPa) Бар (МПа) 巴 (兆帕)	10 (1)
11		m 米	1
12		mm 毫米	775x570x1020
13		kg кг	89
14	 $K_{PA} = 3 \text{ dB}$	dB(A) дБ(A)	75
15	 $K_{WA} = 3 \text{ dB}$	dB(A) дБ(A)	88
16	 (ISO 5349 a_h)	m/s ² 米/秒 ²	≤ 2,5
17		N	57,8
18		l 升	1,1
19			Castrol Alphasyn T 150

1			EN: Country variant. DE: Ländervarianten. FR: Selon le pays. NL: Nationale variant. IT: Variante per il Paese. NO: Variant i ulike land. SV: Landsvariant. DA: Landespecifik variant. FI: Maakohmainen vaihtelu. ES: Dependé del país. PT: Variante do país. EL: Έκδοση χώρας. TR: Ülke-deki model. SL: Jezikovna različica. HR: Ovisno o zemlji. SK: Vrsta ulja. CS: Varianta země. PL: Wersja dla kraju. HU: Országfüggő modellváltozatok. RO: Varianta țării. BG: Вариант за страната. RU: Региональное исполнение. ET: Riigi variant. LV: Valsts versija. LT: Šaliai skirtas variantas. JA: 国による相違。 ZH: 不同国家 KO: 국가별 모델. TH: แตกต่างกันไปตามประเทศ MS: Variasi negara.
2		V/ph/Hz	EN: Possible voltage. DE: Mögliche Spannung. FR: Tension autorisée. NL: Mogelijke spanning. IT: Possibile voltaggio. NO: Mulig spenning. SV: Möjlig spänning. DA: Spænding. FI: Mahdollinen jännite, V/vaiheluku/taajuus. ES: Tensión admitida. PT: Tensão possível. EL: Πιθανή τάση, V/ph/Frez. TR: Olası voltaj, V/Faz/Frekans. SL: Morebitna napetost. HR: Mogući napon. SK: Možné napätie. CS: Možné napětí. PL: Dopuszczalne napięcie, V/fazy/częst. HU: Tápészültség, V/fázis/frekv. RO: Tensiune posibilă, V/fază/Frecv. BG: Възможно напрежение. RU: Напряжение, В/φ./част. В/φ./Гц. ET: Võimalik pinge, V/faas/sagedus. LV: iespējamais spriegums. LT: Galima įtampa V / F / Frez. JA: 電圧。 ZH: 可能电压 (V / ph / Freq) KO: 허용 전압, 볼트/상/헤르츠. TH: แรงดันไฟฟ้าที่สามารถใช้ได้ MS: Kemungkinan voltan.
3		A	EN: Fuse. DE: Sicherung. FR: Fusible. NL: Zekering. IT: Fusibile. NO: Sikring. SV: Säkring. DA: Sikring. FI: Sulake. ES: Fusible. PT: Fusível. EL: Ασφάλεια. TR: Sigorta. SL: Varovalka. HR: Osigurač. SK: Poistka. CS: Pojistka. PL: Bezpiecznik. HU: Biztosíték. RO: Siguranță. BG: Предпазител. RU: Предохранитель. ET: Kaitse. LV: Drošinātājs. LT: Saugiklis. JA: ヒューズ. ZH: 保险丝. KO: 퓨즈. TH: ฟิวส์. MS: Fius.
4		kW кВт	EN: Power rating. DE: Nennleistung. FR: Puissance nominale. NL: Nominiaal vermogen. IT: Corrente nominale. NO: Nominell effekt. SV: Märkeffekt. DA: Nominel effekt. FI: Tehontarve. ES: Potencia nominal. PT: Classificação de potência. EL: Ονομαστική ισχύς. TR: Elektrik değerleri. SL: Moč. HR: Oznaka napona. SK: Stanovenie výkonu. CS: Jmenovitý výkon. PL: Moc znamionowa. HU: Névleges teljesítmény. RO: Putere nominală. BG: Мощност. RU: Номинальная мощность кВт. ET: Vooluühik. LV: Nominālā jauda. LT: Galia. JA: 定格電力。 ZH: 额定功率. KO: 전원 등급. TH: อัตรากำลังไฟ. MS: Penarafan kuasa.
5		bar (MPa) Бар (МПа) 巴 (兆帕)	EN: Working pressure. DE: Arbeitsdruck. FR: Pression de service. NL: Werkdruk. IT: Pressione di esercizio. NO: Arbeidstrykk. SV: Arbetstryck. DA: Arbejdstryk. FI: Työpaine. ES: Presión de trabajo. PT: Pressão de trabalho. EL: Πίεση λειτουργίας. TR: Çalışma basıncı. SL: Delovni tlak. HR: Radni tlak. SK: Pracovný tlak. CS: Provozní tlak. PL: Ciśnienie robocze. HU: Üzemi nyomás. RO: Presiune de lucru. BG: Работно налягане. RU: Рабочее давление. ET: Töösurve. LV: Darba spiediens. LT: Darbinis slėgis. JA: 動作圧力。 ZH: 工作压力. KO: 작업 압력. TH: แรงดันขณะใช้งาน. MS: Tekanan kerja.
6		l/h л/час 升/小时	EN: Water flow. DE: Wasserdurchsatz. FR: Débit d'eau. NL: Waterdoorstroming. IT: Flusso dell'acqua. NO: Vanntilførsel. SV: Vattenflöde. DA: Vandmængde. FI: Vedenvirtaus. ES: Flujo de agua. PT: Fluxo de água. EL: Ροή νερού. TR: Su akışı. SL: Pretok vode. HR: Regulacija protoka vode. SK: Prietok vody. CS: Průtok vody. PL: Przepływ wody. HU: Vízfolyás. RO: Debit apă. BG: Воден поток. RU: Расход воды. ET: Veevool. LV: Ūdens plūsma. LT: Vandens srautas. JA: 流水. ZH: 水流量. KO: 급수량. TH: การไหลของน้ำ. MS: Aliran air.

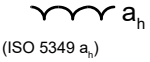
7		bar (MPa) Бар (МПа) 巴 (兆帕)	<p>EN: Max. water pressure. DE: Max Wasserdruck. FR: Pression d'eau maximale. NL: Max. waterdruk. IT: Max. pressione dell'acqua. NO: Maks. vanntrykk. SV: Max vattentryck. DA: Max. vandtryk. FI: Suurin vedempaine. ES: Presión máxima de entrada del agua. PT: Pressão máxima de água. EL: Μέγ. πίεση νερού. TR: Maks. su basıncı. SL: Najv. vodni tlak. HR: Maksimalni tlak vode. SK: Maximálny tlak vody. CS: Max. tlak vody. PL: Maks. ciśnienie wody. HU: Max. víznyomás. RO: Presiune max. apă. BG: Макс. налягане на водата. RU: Макс. давление воды. ET: Max veesurve. LV: Maks. ūdens spiediens. LT: Maks. vandens slėgis. JA: 最高水圧 ZH: 最大水圧 KO: 최대 수압. TH: ความดันน้ำสูงสุด MS: Tekanan air maksimum.</p>
8		l/h	<p>EN: Water flow DE: Wasserdurchsatz. FR: Débit d'eau. NL: Waterdoorstroming. IT: Flusso dell'acqua. NO: Vanntilførsel. SV: Vattenflöde. DA: Vandmængde. FI: Vedevirtaus. ES: Flujo de agua. PT: Fluxo de água. EL: Ποή νερού. TR: Su akışı. SL: Pretok vode. HR: Protok vode. SK: Prietok vody. CS: Průtok vody. PL: Przepływ wody. HU: Vízátfolyás. RO: Debit apă. BG: Воден поток. RU: Расход воды. ET: Veevool. LV: Ūdens plūsma. LT: Vandens srautas. JA: 流水. ZH: 水流量 KO: 급수량. TH: การไหลของน้ำ MS: Aliran air.</p>
9		°C (°F)	<p>EN: Max water inlet temperature, Intake-Pressure operation. DE: Max Wassereinlasstemperatur - Druckbetrieb. FR: Température max. de l'entrée d'eau en mode admission/pression. NL: Max. Waterinlaattemperatuur Inlaat-Tijdens. Bedrijf. IT: Temperatura max. alimentazione acqua Funzionamento a ingressopressione. NO: Maks. temperatur vanninntak, Inntakstrykk drift. SV: Max ingående vattentemperatur inlopps-tryckdrift. DA: Maks. vandtilgangstemperatur, tilgangstrykdrift. FI: Tuloveden suurin lämpötila, käytettäessä painepesurina. ES: Temperatura y presión máxima de entrada del agua. PT: Temperatura máxima de entrada de água, Funcionamento da pressão de entrada. EL: Μεγ. θερμοκρασία εισόδου νερού-λειτουργίας πίεσης. TR: Maks. su girişi sıcaklığı Emme-Basınçlı çalışma. SL: Najv. vstopna temperatura vode, vstopni tlak pri delovanju. HR: Maks. temperatura ulazne vode, tlak pri usisavanju. SK: Max. vstupná teplota vody, Prevádzka v nasávacom režime pod tlakom. CS: Max. teplota vody na vstupu, provozní sací tlak. PL: Maks. temperatura na dopływie wody z instalacji wodociągowej. HU: Max. bemenő vízhőmérséklet Szívónyomásos üzem. RO: Temperatura max. de admisie apă în cazul alimentării de la robinet. BG: Макс. температура на входящата вода – работа в режим на засмукване. RU: Макс. температура воды на входе (всасывание/подача под давлением). ET: Max vee sisselasketemperatuur Sissevoturõhk töö ajal. LV: Maks. ūdens ieplūdes temperatūra ieplūdes-spiediena darbībā. LT: Didžiausia vandens paėmimo temperatūra, veikimas esant įėjimo slėgiui. JA: 最高流入水温度、吸気圧力動作. ZH: 进水压力操作时的最高进水水温 KO: 최대 급수 온도 주입/압력 작동. TH: อุณหภูมิน้ำเข้าสูงสุด ความดันในการใช้งานบริเวณทางเข้า MS: Suhu maksimum air masuk, Kemasukan-Operasi tekanan.</p>
10		bar (MPa) Бар (МПа) 巴 (兆帕)	<p>EN: Max. water inlet pressure. DE: Max. Wassereinlassdruck. FR: d'eau en mode admission/pression. NL: Max. waterinlaatdruk. IT: Pressione max. alimentazione acqua. NO: Maks. trykk vanninntak. SV: Max tryck för vatteninlopp. DA: Maks. Vandtilgangstryk. FI: Tuloveden suurin paine. ES: Presión máxima de entrada del agua. PT: Pressão máxima de entrada de água. EL: Μέγ. πίεση εισόδου νερού. TR: Maks. su girişi basıncı. SL: Najv. tlak dovoda vode. HR: Maks. tlak ulazne vode. SK: Max. vstupný tlak vody. CS: Max. tlak vody na vstupu. PL: Maks. ciśnienie na dopływie wody. HU: Max. bemenő nyomás. RO: Presiunea max. de alimentare cu apă. BG: Макс. налягане на входяща вода. RU: Макс. давление воды на входе. ET: Maks vee sissevoolusurve. LV: Maks. ūdens spiediens. LT: Didžiausias vandens paėmimo slėgis. JA: 最高流入水圧. ZH: 最大进水压力 KO: 최고 급수 압력. TH: ความดันน้ำเข้าสูงสุด MS: Tekanan maksimum air masuk.</p>

11		m 米	<p>EN: Max dry suction height. DE: Max. Trockensaughöhe. FR: Hauteur d'aspiration à sec max. NL: Max. droge aanzuighoogte. IT: Altezza massima di aspirazione secco. NO: Maks. sugehøyde tørr. SV: Max torr-sugningshöjd. DA: Maks. sugehøjde, tør. FI: Suurin kuivaimukorkeus. ES: Altura máxima de succión en seco. PT: Altura de aspiração a seco máx. EL: Μέγ. ύψος αναρρόφησης. TR: Maks. Kuru emme yüksekliği. SL: Najv. višina suhega vsesavanja. HR: Maks. visina pri suhom usisavanju. SK: Max. suchá nasávacia výška. CS: Max. sací výška nasucho. PL: Maks. wysokość ssania na sucho. HU: Max. száraz szívómagasság. RO: Înălțime max. de aspirare în cazul alimentării cu apă dintr-un recipient. BG: Макс. височина на сухо засмукване. RU: Макс. высота всасывания. ET: Max kuivimu kõrgus. LV: Maks. sausās sūkšanas augstums. LT: Maksimalus sausas įsiurbimo aukštis. JA: 最大乾燥吸込高さ。 ZH: 最大干吸高度 米 KO: 최대 건조 흡입 높이. TH: ความสูงของท่อดูดแห้งสูงสุด MS: Ketinggian maksimum sedutan kering.</p>
12		mm 毫米	<p>EN: Dimensions LxWxH. DE: Masse LxBxH. FR: Dimensions l x p x h. NL: Afmetingen LxBxH. IT: Dimensioni, lun. x larg. x alt. NO: Mål LxBxH. SV: Dimensioner LxBxH. DA: Mål LxBxH. FI: Mitat, PxLxK. ES: Dimensiones l x a x al. PT: Dimensões, C x L x A. EL: Διαστάσεις, Μ x Π x Υ. TR: Boyutlar, u x g x y. SL: Mere D x Š x V. HR: Dimenzije DxŠxV. SK: Rozmery D x Š x V. CS: Rozměry d x š x v. PL: Wymiary długość x szer. x wys. HU: Méretek H x Sz x M. RO: Dimensiuni. L x l x î. BG: Размери Д x Ш x В. RU: Размеры, Дл. x Шир. x Выс. ET: Mõõtmed p x l x k. LV: Izmēri G x P x A. LT: Matmenys (i x p x a). JA: 外形寸法長さx幅x高さ。 ZH: 尺寸 (长x宽x高) 毫米 KO: 크기(l x w x h). TH: ขนาด ยาว x กว้าง x สูง MS: Dimensi LxWxH.</p>
13		kg кг	<p>EN: Weight. DE: Gewicht. FR: Poids du nettoyeur. NL: Gewicht van de hogedrukreiniger. IT: Peso dell'idropulitrice. NO: Vekt høytrykksvasker. SV: Maskinens vikt. DA: Vægt. FI: Pelkän painepesurin paino. ES: Peso del limpiador. PT: Peso da máquina de limpeza. EL: Βάρος μηχανήματος καθαρισμού. TR: Temizlik makinesinin yüksekliği. SL: Masa. HR: Težina. SK: Hmotnosť. CS: Hmotnost čisticího stroje. PL: Ciężar myjki. HU: Tisztítógép tömege. RO: Greutatea aparatului. BG: Тегло. RU: Вес моющей машины. ET: Pesuri kaal. LV: Tīrītāja svars. LT: Valymo įrenginio svoris. JA: 重量。 ZH: 清洗机重量 KO: 세척기 무게. TH: น้ำหนัก MS: Berat.</p>
14	 <p>$K_{PA} = 3 \text{ dB}$</p>	dB(A) дБ(А)	<p>EN: Sound pressure level L_{PA}. DE: Schalldruckpegel. FR: Niveau de pression acoustique. NL: Geluidsdrukniveau. IT: Livello pressione sonora. NO: Lydtrykknivå. SV: Ljudtrycksnivå. DA: Lydtryksniveau. FI: Äänenpainetaso. ES: Nivel de presión sonora. PT: Nível de pressão acústica. EL: Επίπεδο πίεσης ήχου. TR: Göre ses basıncı seviyesi. SL: Raven zvočnega tlaka. HR: Razina zvučnog tlaka. SK: Hladina zvukového. CS: Hladina akustického tlaku. PL: Poziom ciśnienia akustycznego. HU: Hangnyomásszint. RO: Nivel de presiune acustică. BG: Ниво на звуково налягане. RU: Уровень шума. ET: Helisurve tase. LV: Akustiskā spiediena līmenis. LT: Garso slėgio lygis. JA: 音圧レベル. ZH: 声压级. KO: 음압 레벨. TH: ระดับความดันเสียง. MS: Tahap tekanan bunyi.</p>
15	 <p>$K_{WA} = 3 \text{ dB}$</p>	dB(A) дБ(А)	<p>EN: Sound power level L_{WA}. DE: Schallleistungspegel. FR: Niveau de puissance acoustique. NL: Geluidsvermogeniveau. IT: Livello potenza sonora. NO: Lydeffektnivå. SV: Ljudeffektnivå. DA: Lydeffektniveau. FI: Äänen tehotaso. ES: Potencia acústica. PT: Nível de potência acústica. EL: Επίπεδο ισχύος ήχου. TR: Göre ses basıncı seviyesi. SL: Raven moči zvoka. HR: Razina jakosti. SK: Hladina zvukového výkonu. CS: Hladina akustického výkonu. PL: Poziom mocy akustycznej. HU: Hangteljesítmény szint. RO: Nivelul de putere acustică. BG: Ниво на звукова мощност. RU: Уровень звуковой мощности. ET: Helivõimsuse tase. LV: Akustiskās jaudas līmenis. LT: Garso galios lygis. JA: 音響パワーレベル. ZH: 声功率级. KO: 소음 레벨. TH: ระดับกำลังเสียง. MS: Tahap kuasa bunyi.</p>

16a		m/s^2 米/秒 ²	EN: Vibration. DE: Vibrationen FR: Vibration NL: Vibratie IT: Vibrazioni NO: Vibrasjoner SV: Vibration DA: Vibration FI: Tärinäarvot ES: Vibración PT: Vibração EL: Δόνηση TR: Titreşimi SL: Vibracije. HR: Vibracije. SK: Vibrácie. CS: Vibrace PL: Drgania HU: Vibráció RO: Vibrații BG: Вибрации. RU: Вибрация ET: vibratsioon LV: vibrācija LT: Vibracijos JA: 振動。 ZH: 振动 KO: 진동 TH: แรงสั่นสะเทือน MS: Getaran.
17		N	EN: Recoil forces, lance. DE: Rückstoßkraft, Sprühhrohr FR: Forces de recul, lance NL: Terugslagkracht, lans IT: Forze di rinculo, lancia NO: Rekylkraft, lanse SV: Rekylkraft, spolrör DA: Rekylkraft, dyserør FI: Rekyylivoimat, suutin ES: Fuerzas de retroceso, lanza PT: Forças de retrocesso, lança EL: Δυνάμεις οπισθοδρόμησης, διάταξη ψεκασμού χη. TR: Sarmal kuvvetler, boru SL: Povratne sile, šoba. HR: Trzajne sile, mlaznica. SK: Spätný odraz, štandardná striekacia rúra. CS: Síly zpětného rázu, násadec PL: Siły odrzutu, lanca HU: Visszaható erő, szórócső RO: Forțe de recul, tija BG: Сили на откат, накрайник. RU: Сила отдачи (распылитель). ET: Tagasilöögi jõud, otsik LV: Atsitiena spēks, smidzinātājs LT: Atatrankos jėga, antgalis JA: 反跳力、ランス。 ZH: 反冲力 (喷杆) KO: 반동력, 랜스 TH: แรงสะท้อนถอยหลัง, ป้ายทอ MS: Kuasa sentakan, lans.
18		l 升	EN: Oil quantity. DE: Ölmenge. FR: Quantité d'huile. NL: Hoeveelheid olie. IT: Quantità olio. NO: Oljemengde. SV: Oljemängd. DA: Oliemængde. FI: Öljymäärä. ES: Cantidad de aceite. PT: Quantidade de óleo. EL: Ποσότητα λαδιού. TR: Yağ miktarı. SL: Količina olja. HR: Količina ulja. SK: Množstvo oleja. CS: Množství oleje. PL: Objętość oleju. HU: Olajmennyiség. RO: Cantitate de ulei. BG: Количество на маслото. RU: Количество масла. ET: Õli kogus. LV: Eļļas daudzums. LT: Tepalo kiekis. JA: オイル量。 ZH: 油量升 KO: 오일량 TH: ปริมาณน้ำมัน MS: Kuantiti minyak.
19			EN: Oil type. DE: Öltyp. FR: Type d'huile. NL: Olietype. IT: Tipo olio. NO: Oljetype. SV: Typ av olja. DA: Olietype. FI: Öljyn tyyppi. ES: Tipo de aceite. PT: Tipo de óleo. EL: Τύπος λαδιού. TR: Yağ tipi. SL: Vrsta olja. HR: Vrsta ulja. SK: Typ oleja. CS: Typ oleje. PL: Typ oleju. HU: Olaj típusa. RO: Tip de ulei. BG: Тип на маслото. RU: Тип масла. ET: Õli tüüp. LV: Eļļas tips. LT: Tepalo tipas. JA: オイルの種類。 ZH: 油型 KO: 오일 유형 TH: ประเภทน้ำมัน MS: Jenis minyak.
20			EN: Specifications and details are subject to change without prior notice. DE: Technische Daten und Details des Geräts können sich ohne vorherige Ankündigung ändern. FR: Ces spécifications et détails sont susceptibles d'être modifiés sans préavis. NL: Specificaties en details kunnen zonder voorafgaande waarschuwing worden gewijzigd. IT: Specifiche e dettagli sono soggetti a modifiche senza preavviso. NO: Spesifikasjonene og detaljene er gjenstand for endringer uten forutgående varsel. SV: Specifikationer och information kan ändras utan föregående meddelande. DA: Ret til ændringer i konstruktion og specifikationer forbeholdes. FI: Rakenteeseen ja teknisiin tietoihin voidaan tehdä muutoksia ilmoittamatta niistä ennalta. ES: Las especificaciones y los datos están sujetos a cambios sin previo aviso. PT: As especificações e os detalhes estão sujeitos a alterações sem aviso prévio. EL: Τα τεχνικά χαρακτηριστικά και οι λεπτομέρειες υπόκεινται σε αλλαγές χωρίς προηγούμενη ειδοποίηση. TR: Özellikler ve ayrıntılar, önceden haber verilmeden değiştirilebilir. SL: Tehnični podatki in podrobnosti se lahko spremenijo brez predhodnega obvestila. HR: Specifikacije i detalji mogu se mijenjati bez prethodne najave. SK: Špecifikácie a podrobnosti sa môžu meniť bez predchádzajúceho upozornenia. CS: Technické údaje a detaily mohou být změněny i bez předchozího upozornění. PL: Specyfikacje i parametry mogą zostać zmienione bez uprzedzenia. HU: A műszaki adatok és részletek előzetes értesítés nélkül megváltozhatnak. RO: Specificațiile și detaliile pot fi modificate fără înștiințare prealabilă. BG: Спецификациите и детайлите подлежат на промяна без предварително уведомление. RU: Технические характеристики и данные могут изменяться без предварительного извещения. ET: Tehnilisi kirjeldusi ja üksikasju võidakse muuta eelneva etteteatamiseta. LV: Specifikācijas un detaļas var tikt mainītas bez iepriekšēja paziņojuma. LT: Konstrukcija ir specifikacijos gali keistis be išankstinio įspėjimo. JA: 仕様および情報は事前通知無しに変更する場合があります。 ZH: 规格和详情如有变更，恕不另行通知。 KO: 사양 및 내용은 예고없이 변경될 수 있습니다. TH: ข้อกำหนดเฉพาะและรายละเอียดสามารถเปลี่ยนแปลงได้โดยไม่ต้องแจ้งให้ทราบล่วงหน้า MS: Spesifikasi dan butiran adalah tertakluk kepada perubahan tanpa notis terlebih dahulu.



HEAD QUARTER

DENMARK

Nilfisk A/S
Kornmarksvej 1
DK-2605 Broendby
Tel.: (+45) 4323 8100
www.nilfisk.com

SALES COMPANIES

ARGENTINA

Nilfisk Argentina
Herrera 1855 Piso 4° B Ofic 405
Ciudad de Buenos Aires
Tel.: (+54) 11 6091 1576
www.nilfisk.com.ar

AUSTRALIA

Nilfisk Pty Ltd
Unit 1/13 Bessemer Street
Blacktown NSW 2148
Tel.: (+61) 2 98348100
www.nilfisk.com.au

AUSTRIA

Nilfisk GmbH
Metzgerstrasse 68
5101 Bergheim bei Salzburg
Tel.: (+43) 662 456 400 90
www.nilfisk.at

BELGIUM

Nilfisk n.v.s.a.
Riverside Business Park
Boulevard Internationalelaan 55
Bâtiment C3/C4 Gebouw
Bruxelles 1070
Tel.: (+32) 24 67 60 50
www.nilfisk.be

BRAZIL

Nilfisk do Brasil
Av. Eng. Luis Carlos Berrini, 550
40 Andar, Sala 03
SP - 04571-000 Sao Paulo
Tel.: (+11) 3959-0300 / 3945-4744
www.nilfisk.com.br

CANADA

Nilfisk Canada Company
240 Superior Boulevard
Mississauga, Ontario L5T 2L2
Tel.: (+1) 800-668-8400
www.nilfisk.ca

CHILE

Nilfisk S.A. (Comercial KCS Ltda)
Salar de Llamara 822
8320000 Santiago
Tel.: (+56) 2684 5000
www.nilfisk.cl

CHINA

Nilfisk
4189 Yindu Road
Xinzhuan Industrial Park
201108 Shanghai
Tel.: (+86) 21 3323 2000
www.nilfisk.cn

CZECH REPUBLIC

Nilfisk s.r.o.
VGP Park Horní Počernice
Do Čertous 1/2658
193 00 Praha 9
Tel.: (+420) 244 090 912
www.nilfisk.cz

DENMARK

Nilfisk Danmark A/S
Industrivej 1
Hadsund, DK-9560
Tel.: 72 18 21 20
www.nilfisk.dk

FINLAND

Nilfisk Oy Ab
Koskelontie 23 E
02920 Espoo
Tel.: (+358) 207 890 600
www.nilfisk.fi

FRANCE

Nilfisk SAS
26 Avenue de la Baltique
Villebon sur Yvette
91978 Courtabouef Cedex
Tel.: (+33) 169 59 87 00
www.nilfisk.fr

GERMANY

Nilfisk GmbH
Guido-Oberdorfer-Straße 2-10
89287 Bellenberg
Tel.: (+49) (0)7306/72-444
www.nilfisk.de

GREECE

Nilfisk A.E.
Αναπαύσεως 29
Κορωπί T.K. 194 00
Tel.: (30) 210 9119 600
www.nilfisk.gr

HOLLAND

Nilfisk B.V.
Versterkerstraat 5
1322 AN Almere
Tel.: (+31) 036 5460760
www.nilfisk.nl

HONG KONG

Nilfisk Ltd.
2001 HK Worsted Mills
Industrial Building
31-39, Wo Tong Tsui St.
Kwai Chung, N.T.
Tel.: (+852) 2427 5951
www.nilfisk.com

HUNGARY

Nilfisk Kft.
II. Rákóczi Ferenc út 10
2310 Szigetszentmiklós-Lakihegy
Tel.: (+36) 24 475 550
www.nilfisk.hu

INDIA

Nilfisk India Limited
Pramukh Plaza, 'B' Wing, 4th floor,
Unit No. 403
Cardinal Gracious Road, Chakala
Andheri (East) Mumbai 400 099
Tel.: (+91) 22 6118 8188
www.nilfisk.in

IRELAND

Nilfisk
1 Stokes Place
St. Stephen's Green
Dublin 2
Tel.: (+35) 3 12 94 38 38
www.nilfisk.ie

ITALY

Nilfisk SpA
Strada Comunale della Braglia, 18
26862 Guardamiglio (LO)
Tel.: (+39) (0) 377 414021
www.nilfisk.it

JAPAN

Nilfisk Inc.
1-6-6 Kita-shinyokohama, Kouhoku-ku
Yokohama, 223-0059
Tel.: (+81) 45548 2571
www.nilfisk.com

MALAYSIA

Nilfisk Sdn Bhd
Sd 33, Jalan KIP 10
Taman Perindustrian KIP
Sri Damansara
52200 Kuala Lumpur
Tel.: (60) 3603 627 43 120
www.nilfisk.com

MEXICO

Nilfisk de Mexico, S. de R.L. de C.V.
Pirineos #515 Int.
60-70 Microparque
Industrial WSantiago
76120 Queretaro
Tel.: (+52) (442) 427 77 00
www.nilfisk.com

NEW ZEALAND

Nilfisk Limited
Suite F, Building E
42 Tawa Drive
0632 Albany Auckland
Tel.: (+64) 9 414 1996
Website: www.nilfisk.com

NORWAY

Nilfisk AS
Bjørnerudveien 24
1266 Oslo
Tel.: (+47) 22 75 17 80
www.nilfisk.no

PERU

Nilfisk S.A.C.
Calle Boulevard 162, Of. 703, Lima
33- Perú
Lima
Tel.: (511) 435-6840
www.nilfisk.com

POLAND

Nilfisk Sp. Z.O.O.
Millenium Logistic Park
ul. 3 Maja 8, Bud. B4
05-800 Pruszków
Tel.: (+48) 22 738 3750
www.nilfisk.pl

PORTUGAL

Nilfisk Lda.
Sintra Business Park
Zona Industrial Da Abrunheira
Edifício 1, 1° A
P2710-089 Sintra
Tel.: (+351) 21 911 2670
www.nilfisk.pt

RUSSIA

Nilfisk LLC
Vyatskaya str. 27, bld. 7/1st
127015 Moscow
Tel.: (+7) 495 783 9602
www.nilfisk.ru

SINGAPORE

Den-Sin
22 Tuas Avenue 2
639453 Singapore
Tel.: (+65) 6268 1006
www.densin.com

SLOVAKIA

Nilfisk s.r.o.
Bancikovej 1/A
SK-821 03 Bratislava
Tel.: (+421) 910 222 928
www.nilfisk.sk

SOUTH AFRICA

Nilfisk (Pty) Ltd
Kimbult Office Park
9 Zeiss Road
Laser Park
Honeydew
Johannesburg
Tel.: +27118014600
www.nilfisk.co.za

SOUTH KOREA

Nilfisk Korea
#204 2F Seoulsup Kolon Digital
Tower
25 Seongsuil-ro 4-gil, Seongdong-gu
Seoul.
Tel.: (+ 82) 2 3474 4141
www.nilfisk.co.kr

SPAIN

Nilfisk S.A.
Torre d'Ara,
Passeig del Rengle, 5 Plta. 10ª
08302 Mataró
Tel.: (34) 93 741 2400
www.nilfisk.es

SWEDEN

Nilfisk AB
Taljegårdsgatan 4
431 53 Mölndal
Tel.: (+46) 31 706 73 00
www.nilfisk.se

SWITZERLAND

Nilfisk AG
Ringstrasse 19
Kircheberg/Industri Stelz
9500 Wil
Tel.: (+41) 71 92 38 444
www.nilfisk.ch

TAIWAN

Nilfisk Ltd
Taiwan Branch (H.K.)
No. 5, Wan Fang Road
Taipei
Tel.: (+88) 6227 00 22 68
www.nilfisk.tw

THAILAND

Nilfisk Co. Ltd.
89 Soi Chokechai-Ruammitr
Viphavadee-Rangsit Road
Ladyao, Jatuchak, Bangkok 10900
Tel.: (+66) 2275 5630
www.nilfisk.co.th

TURKEY

Nilfisk A.S.
Serifali Mh. Bayraktar Bulv. Sehiz
Sk. No:7
Ümraniye, 34775 Istanbul
Tel.: +90 216 466 94 94
www.nilfisk.com.tr

UNITED ARAB EMIRATES

Nilfisk Middle East Branch
SAIF-Zone
P.O. Box 122298
Sharjah
Tel.: (+971) (0) 655-78813
www.nilfisk.com

UNITED KINGDOM

Nilfisk Ltd.
Nilfisk House, Bowerbank Way
Gilwilly Industrial Estate, Penrith
Cumbria CA11 9BQ
Tel.: (+44) (0) 1768 868995
www.nilfisk.co.uk

UNITED STATES

Nilfisk, Inc.
9435 Winnetka Ave N,
Brooklyn Park
MN- 55445
www.nilfisk.com

VIETNAM

Nilfisk Vietnam
No. 51 Doc Ngu Str.
P. Vinh Phúc, Q.Ba Dinh
Hanoi
Tel.: (+84) 761 5642
www.nilfisk.com

